

ICF-C420/C425

SERVICE MANUAL

Canadian Model
AEP Model
E Model
Australian Model
ICF-C420
Germany Model
Italian Model
ICF-C425

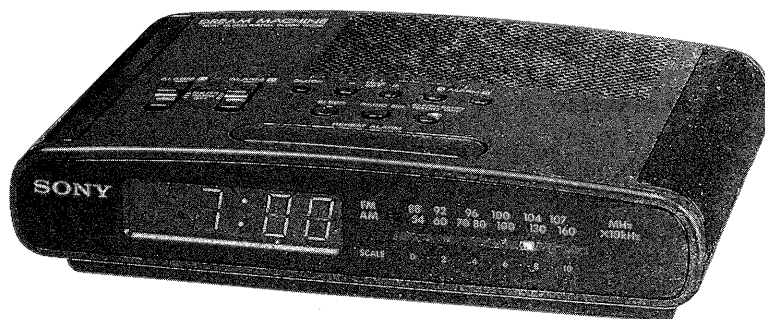

Photo : ICF-C425 (Black Type)

TABLE OF CONTENTS

<u>Section</u>	<u>Title</u>	<u>Page</u>
	Specifications	3
	Features	3
1. GENERAL		3
2. ELECTRICAL ADJUSTMENTS		6
3. DIAL POINTER SETTING		
3-1. Dial Pointer Setting		7
4. DIAGRAMS		
4-1. Printed Wiring Board		9
4-2. Schematic Diagram		11
5. EXPLODED VIEW		13
6. ELECTRICAL PARTS LIST		14

FM/AM DIGITAL CLOCK RADIO
SONY®

SAFETY CHECK-OUT (US Model)

After correcting the original service problem, perform the following safety check before releasing the set to the customer:

Check the antenna terminals, metal trim, "metallized" knobs, screws, and all other exposed metal parts for AC leakage. Check leakage as described below.

LEAKAGE TEST

The AC leakage from any exposed metal part to earth ground and from all exposed metal parts to any exposed metal part having a return to chassis, must not exceed 0.5 mA (500 microampers). Leakage current can be measured by any one of three methods.

1. A commercial leakage tester, such as the Simpson 229 or RCA WT-540A. Follow the manufacturers' instructions to use these instruments.
2. A battery-operated AC milliammeter. The Data Precision 245 digital multimeter is suitable for this job.
3. Measuring the voltage drop across a resistor by means of a VOM or battery-operated AC voltmeter. The "limit" indication is 0.75 V, so analog meters must have an accurate low-voltage scale. The Simpson 250 and Sanwa SH-63Trd are examples of a passive VOM that is suitable. Nearly all battery operated digital multimeters that have a 2V AC range are suitable. (See Fig. A)

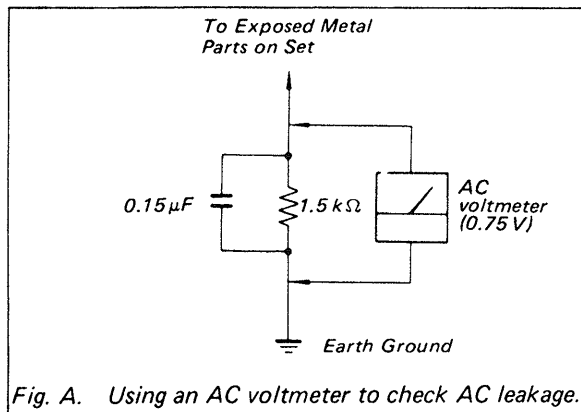





Fig. A. Using an AC voltmeter to check AC leakage.

SAFETY-RELATED COMPONENT WARNING!!

COMPONENTS IDENTIFIED BY MARK  OR DOTTED LINE WITH MARK  ON THE SCHEMATIC DIAGRAMS AND IN THE PARTS LIST ARE CRITICAL TO SAFE OPERATION. REPLACE THESE COMPONENTS WITH SONY PARTS WHOSE PART NUMBERS APPEAR AS SHOWN IN THIS MANUAL OR IN SUPPLEMENTS PUBLISHED BY SONY.

ATTENTION AU COMPOSANT AYANT RAPPORT À LA SÉCURITÉ!

LES COMPOSANTS IDENTIFIÉS PAR UNE MARQUE  SUR LES DIAGRAMMES SCHÉMATIQUES ET LA LISTE DES PIÈCES SONT CRITIQUES POUR LA SÉCURITÉ DE FONCTIONNEMENT. NE REMPLACER CES COMPOSANTS QUE PAR DES PIÈCES SONY DONT LES NUMÉROS SONT DONNÉS DANS CE MANUEL OU DANS LES SUPPLÉMENTS PUBLIÉS PAR SONY.

MODEL IDENTIFICATION

- Model Number Label -

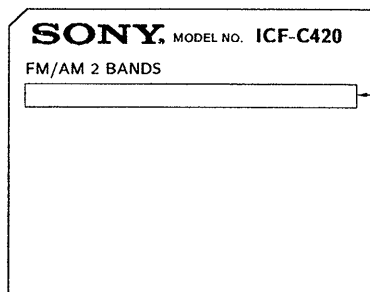

{ Canadian, E92 Model : AC120V 60Hz 3W
 AEP, E91 Model : AC220V-230V 50Hz 3W
 AUS Model : AC240V ~ 50Hz 3W

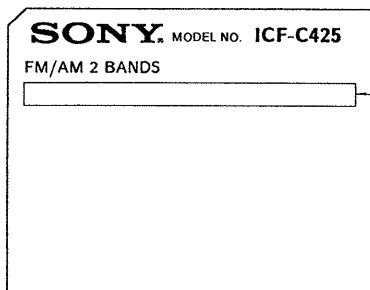

Germany, IT Model : AC220-230V 50Hz 3W

Specifications

Frequency range

	Band	ICF-C420/C425
Italy	FM	87.5 — 108 MHz
	AM	526.5 — 1606.5 kHz
Other countries	FM	87.6 — 107.5 MHz
	AM (MW)	531 — 1602 kHz
	LW	—

Intermediate frequency FM: 10.7 MHz, AM: 455 kHz

Antennas

FM: FM wire antenna
AM (MW)/LW: Built-in ferrite bar antenna

Speaker

Approx. 6.6 cm (2⁵/₈ inches) dia.

Power output

100 mW (at 10% harmonic distortion)

Power requirement

UK, Australia	240 V AC, 50 Hz
Other countries	220—230 V AC, 50 Hz

For the power back-up function:

9 V DC, one 6F22 battery

Battery life

Approx. 29 hours, using Sony battery S-006P (U)

Dimensions

Approx. 224 × 58.8 × 151 mm (w/h/d)
(8⁷/₈ × 2³/₈ × 6 inches) incl. projecting parts and controls

Weight

Approx. 630g (1 lb 6 oz) not incl. battery

Design and specifications subject to change without notice.

Note

This appliance conforms with EEC Directive 87/308/EEC regarding interference suppression.

Features

- Dual alarm digital clock radio.
- Choice of radio or buzzer awakening sound for both ALARM **A** and ALARM **B**.
- REPEAT ALARM: snooze alarm that can be operated with a feather-light touch.
- Power back-up function to keep the clock operating during a power interruption, using a 6F22 battery (not supplied).

SECTION 1 GENERAL

This section is extracted from instruction manual.

A Location of Controls

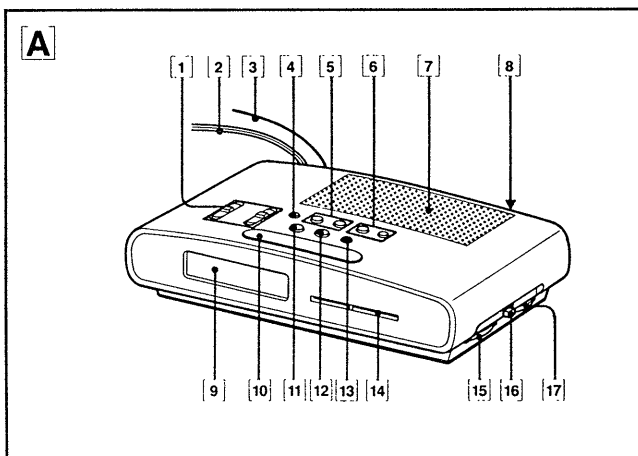

- | | |
|---|---|
| 1 Alarm selectors (ALARM A , ALARM B): BUZZER/RADIO/OFF | 9 Time display |
| 2 AC power cord | 10 REPEAT ALARM bar |
| 3 FM wire antenna | 11 SLEEP button |
| 4 CLOCK set button | 12 RADIO ON button |
| 5 TIME SET buttons (+/-) | 13 ALARM RESET/RADIO OFF button |
| 6 ALARM set buttons (A / B) | 14 Dial scale |
| 7 Speaker | 15 TUNING control |
| 8 Power back-up battery compartment (bottom) | 16 BAND selector (FM/AM) |
| | 17 VOL (volume) control (bottom) |

C How to Set the Clock

1 Blinks

2 CLOCK TIME SET + -

8:15

The illustrations show the display of the 24-hour system model.

Example: To set to 8:15 AM

1 Connect the AC power cord to a wall outlet.

Figures will appear on the time display and begin to blink.

2 Set the current time.

While keeping CLOCK pressed, press the TIME SET + button (to go forward rapidly) and TIME SET - button (to go backward slowly). Release CLOCK exactly at 8:15 AM. The clock will begin to operate when CLOCK is released.

To set the current time rapidly

Press the + button and advance to a time that is a few minutes ahead of the current time. Then press the - button to set the time correctly.

Zero second adjustment

Example: To set to 7:15 AM

- Adjust the time to 7:16 AM as previously described.
- While keeping CLOCK pressed, press TIME SET - button simultaneously with the radio or telephone time signal, and then release them.

To display minute and second, press REPEAT ALARM.

Example: When the current time is 7:15:10, the display will become:

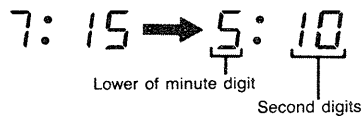

The display returns to the current hour and minute when it is released.

12-hour system model AM 12:00 = Midnight PM 12:00 = Noon	24-hour system model 0:00 = Midnight 12:00 = Noon
---	--

D Radio Operation

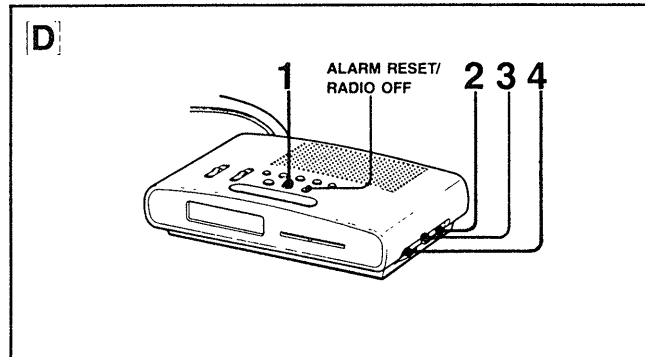

1 Press RADIO ON to turn on the radio.

2 Adjust the volume.

3 Select the desired band.

4 Tune in the desired station.

To turn off the radio

Press ALARM RESET/RADIO OFF.

E For improved reception

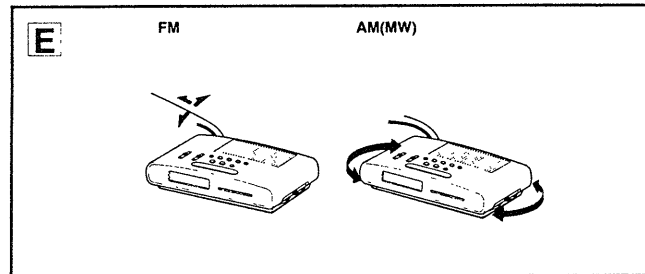

FM: Extend the FM wire antenna fully to increase the FM sensitivity.

AM (MW):

Since the reception is affected by the direction of the radio, rotate the unit horizontally for optimum reception.

F How to Set the Alarm (Radio or BUZZER)

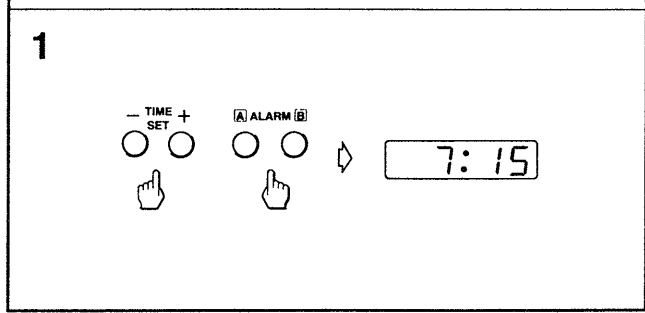
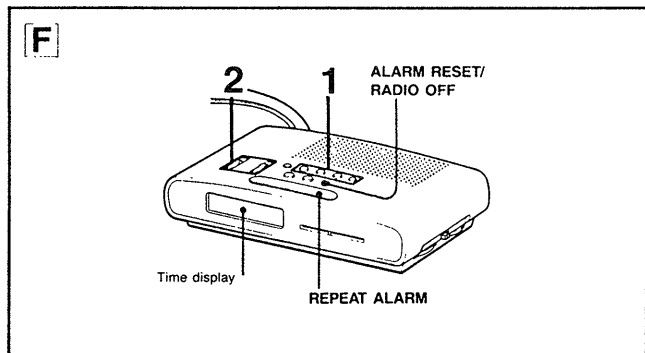

To set the radio alarm, first tune in the desired station and adjust the volume.

Example: To set the alarm time to 7:15 AM.

- 1 **Set the alarm time on the clock.**
While keeping desired ALARM set button ([A] or [B]) pressed, press the TIME SET + button (to go forward rapidly) and the TIME SET - button (to go backward slowly). Release the ALARM set button exactly at 7:15 AM.
- 2 **Set the appropriate alarm selector (ALARM [A] or ALARM [B]) to the desired sound (RADIO or BUZZER).**
The radio or buzzer will automatically sound at the preset time, and automatically turn itself off after 59 minutes, unless it is turned off manually.

To turn off the alarm manually
Press the ALARM RESET/RADIO OFF button. The alarm will sound at the regular preset time on the following day.

Snooze alarm function

To shut off the alarm sound, press ALARM RESET/RADIO OFF, or press REPEAT ALARM when you want to doze a few more minutes. When you press REPEAT ALARM, the alarm sound becomes silent, but will automatically come on again after about seven minutes. You can repeat this function as many times as you like.
If you do not press ALARM RESET/RADIO OFF, the unit shuts off automatically after 59 minutes whether or not you press REPEAT ALARM.

To completely cancel the alarm
Set the desired alarm selector to OFF.

The volume of the alarm sound
The radio volume can be adjusted.
The buzzer volume is fixed.

To check the preset time
Press the desired ALARM set button.

G How to Set the Sleep Timer

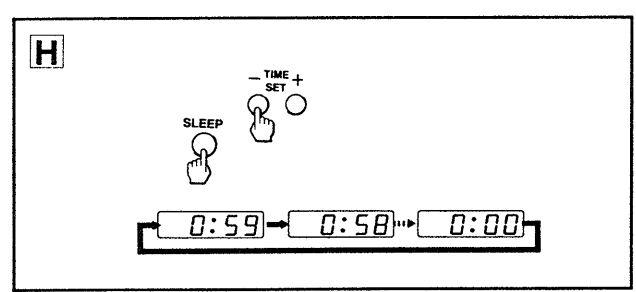
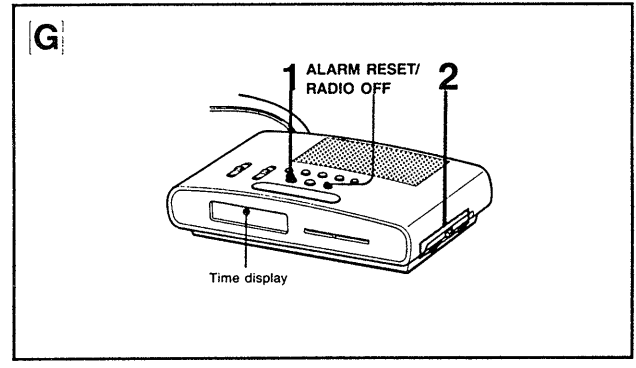

By using the sleep timer, you can fall asleep while listening to the radio. You can set the sleep time so that the radio turns off up to 59 minutes later.

- 1 **Press SLEEP.**
The radio turns on, and will turn off after 59 minutes.

If you want to set the desired time duration (See illustration H.)
While keeping SLEEP pressed, press the TIME SET — button. You can set the time duration within the range from 59 minutes to 1 minute.
- 2 **Tune in the desired station and adjust the volume.**

To turn off the radio before the preset time
Press ALARM RESET/RADIO OFF.

To check the remaining minutes
Press SLEEP lightly.

SECTION 2 ELECTRICAL ADJUSTMENTS

AM Section

Setting

BAND switch : AM

AM rf signal generator



put the lead-wire antenna close to the set

30% amplitude modulation by 400Hz signal
Output level : as low as possible

AM IF ADJUSTMENT	
Adjust for a maximum reading on VTVM	
T1	455kHz

AM FREQUENCY COVERAGE ADJUSTMENT	
Adjust for a maximum reading on VTVM	
L6	520kHz <516.5kHz>
CT4	1650kHz <1631.5kHz>

< > : Italian model only

FM Section

Setting

BAND switch : FM

FM rf signal generator

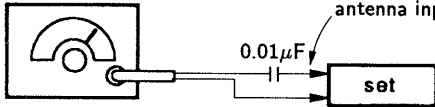

±22.5kHz frequency deviation by 400Hz signal
output level : as low as possible

AM TRACKING ADJUSTMENT	
Adjust for a maximum reading on VTVM	
L3	780kHz
CT1	1360kHz

FM FREQUENCY COVERAGE ADJUSTMENT	
Adjust for a maximum reading on VTVM	
L5	87.35MHz (86.5MHz)
CT3	108.05MHz (109.5MHz) <108.25MHz>

() : Canadian model only
< > : Italian model only

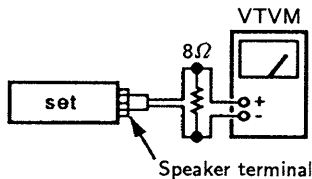

FM TRACKING ADJUSTMENT	
Adjust for a maximum reading on VTVM	
CT2	108.25MHz

- Repeat the procedures in each adjustment several times, and the frequency coverage and tracking adjustments should be finally done by the trimmer capacitors.

ADJUSTMENT LOCATION :

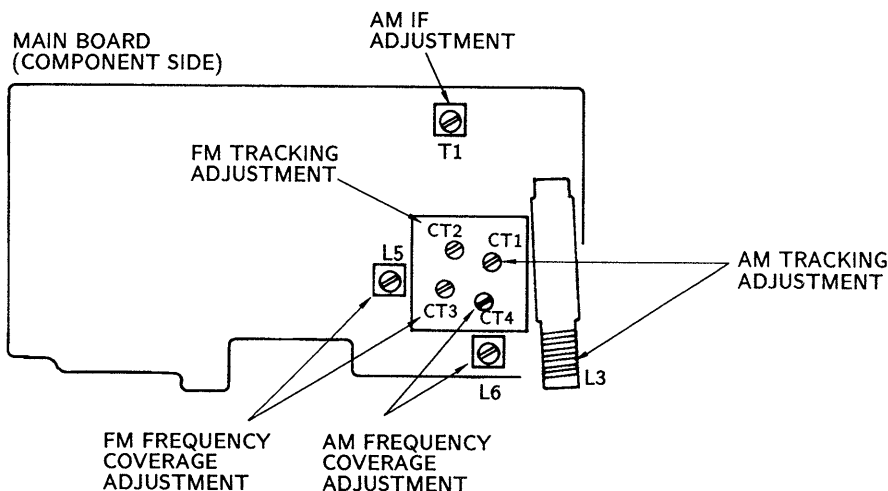

SECTION 3 DIAL POINTER SETTING

3-1. DIAL POINTER SETTING

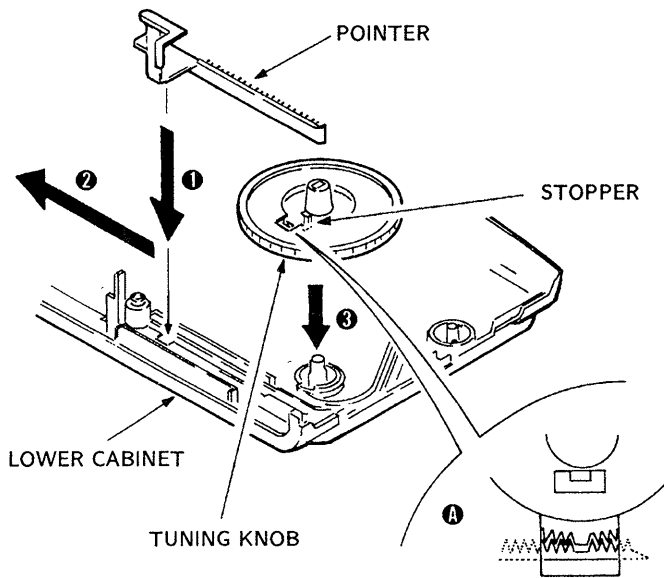

- 1 Fit the gear part of pointer to cabinet groove and hook installing claw while taking pointer out of cabinet.
- 2 Move pointer in the direction of arrow fully.
- 3 Install the gear part of stopper and the gear part of pointer as show in the drawing **A**.
Make sure to fit the stopper to the cabinet hole.

MEMO

A series of horizontal dotted lines for writing.

SECTION 4 DIAGRAMS

• SEMICONDUCTOR LOCATION

Ref. No.	Location
D4	C-3
D5	C-2
D6	E-4
D7	E-5
D8	B-2
D9	B-2
D10	D-4
D11	D-4
D12	D-4
D13	A-3
IC1	D-7
IC2	B-3
Q1	C-6
Q2	D-6
Q3	D-5
Q4	D-5

4-1. PRINTED WIRING BOARD

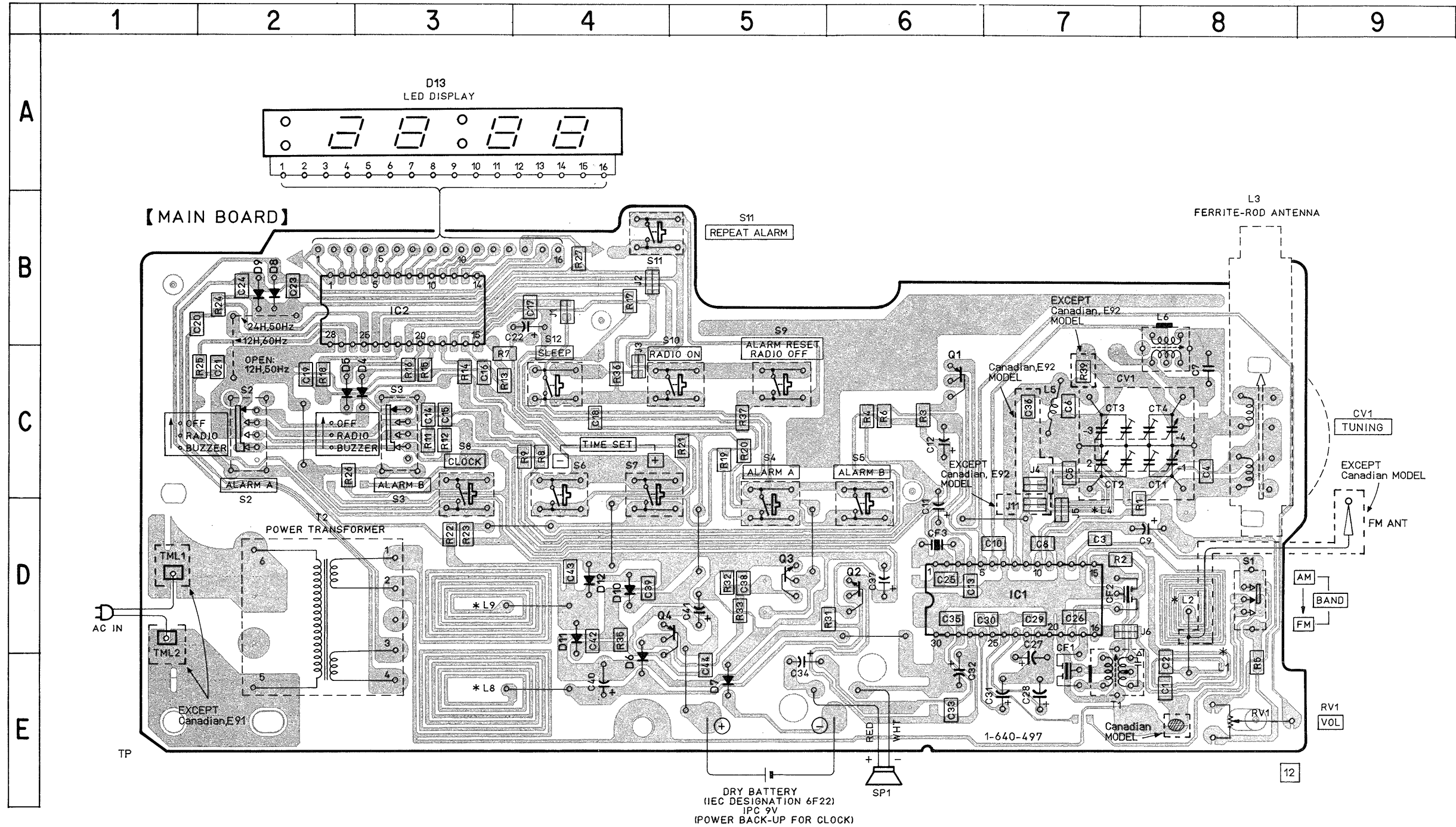

Note :

- : parts extracted from the component side.
- ⊞ : indicates side identified with part number.
- ▨ : Pattern on the side which is seen.
- Never reuse a disconnected chip component.
- Notice that the minus side of a tantalum capacitor may be damaged by heat.
- * : printed pattern functions as a kind of coil.

• SEMICONDUCTOR LEAD LAYOUTS

2SA933S-QR
2SC2001-LK

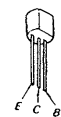

2SC2785-HFE



1SS119

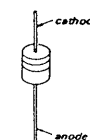

10E2

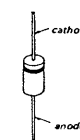

4-2. SCHEMATIC DIAGRAM

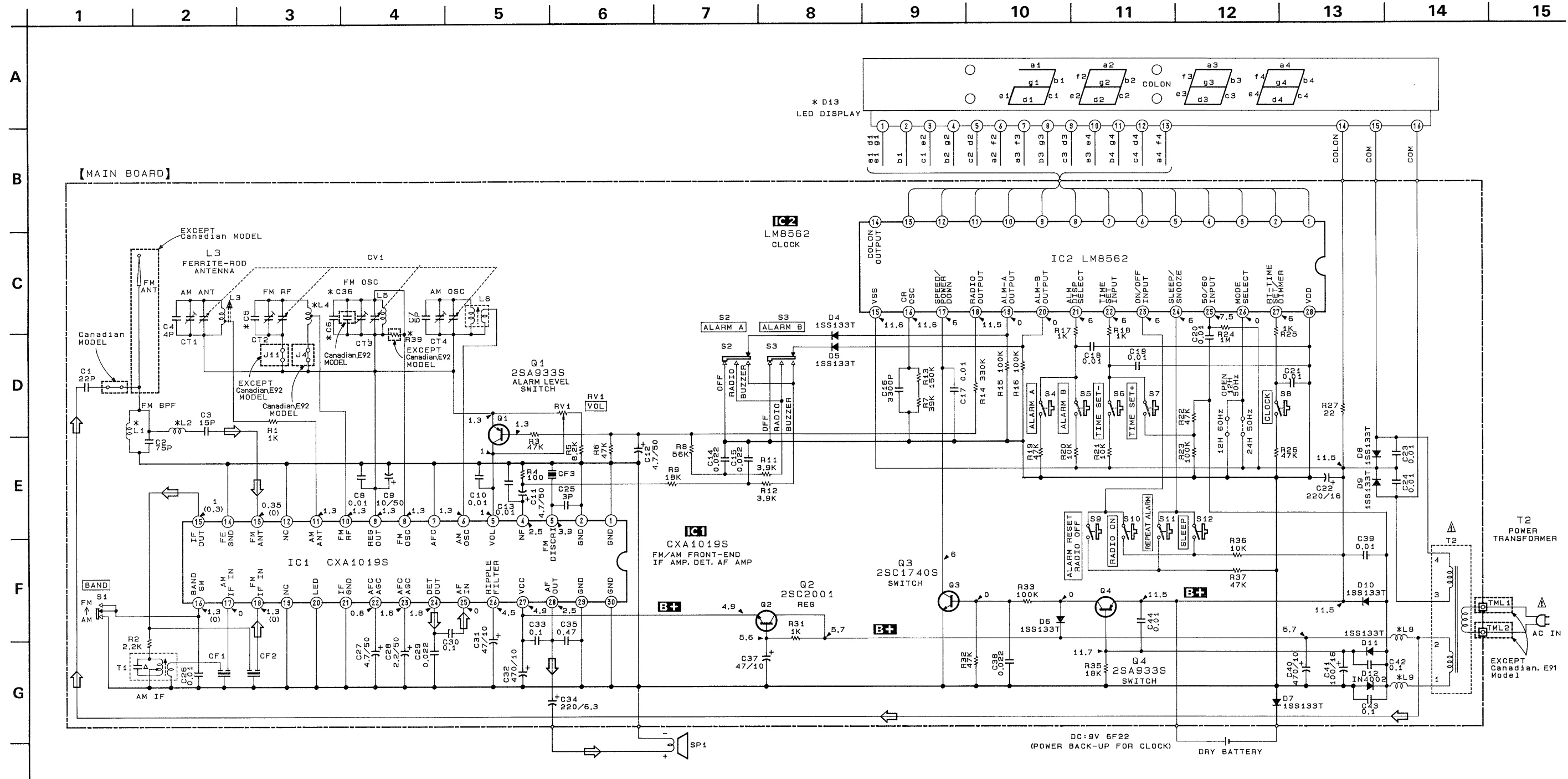

* The following chart is the differed of circuit description.

* L1, 2, 4, 8, 9 : printed pattern functions as a kind of coil.

Ref.	C5	C6	C36	J4	J11	R39	D13
Canadian	22PF	20PF	5PF	0	deleted	deleted	SL-1042-78T
E92	22PF	20PF	5PF	0	deleted	deleted	SL-1042-78T
AEP, E91	27PF	30PF	deleted	deleted	0	2.7k	SL-1042-79T
AUS	27PF	30PF	deleted	deleted	0	2.7k	SL-1042-78T
Germany	27PF	30PF	deleted	deleted	0	2.7k	LED BLOCK(GREEN LED)
IT	27PF	30PF	deleted	deleted	0	2.7k	LED BLOCK(GREEN LED)

E Model | E91 : AC220-230V
| E92 : AC120V

• IC BLOCK DIAGRAM

IC1 CXA1019S

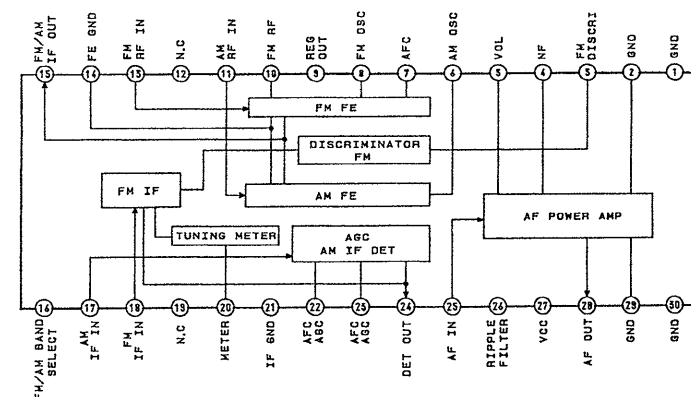

Note :

- All capacitors are in μF unless otherwise noted. pF : $\mu \mu F$ 50WV or less are not indicated except for electrolytics and tantalums.
- All resistors are in Ω and $\frac{1}{4}W$ or less unless otherwise specified.
- Δ : internal component.
- B+** : B+ Line
- Voltage and waveforms are dc with respect to ground under no-signal (detuned) conditions.
- no mark : FM
- () : AM



- Voltages are taken with a VOM (Input impedance 10M Ω). Voltage variations may be noted due to normal production tolerances.
- Signal path.
- \Rightarrow : FM
- * : printed pattern functions as a kind of coil.

SECTION 5 EXPLODED VIEW

NOTE:

- -XX, -X mean standardized parts, so they may have some differences from the original one.
- The construction parts of an assembled part are indicated with a collation number in the remark column.
- Color indication of Appearance Parts Example:
KNOB, BALANCE (WHITE).... (RED)



- Items marked "*" are not stocked since they are seldom required for routine service. Some delay should be anticipated when ordering these items.
- The mechanical parts with no reference number in the exploded views are not supplied.

The components identified by mark  or dotted line with mark  are critical for safety. Replace only with part number specified.

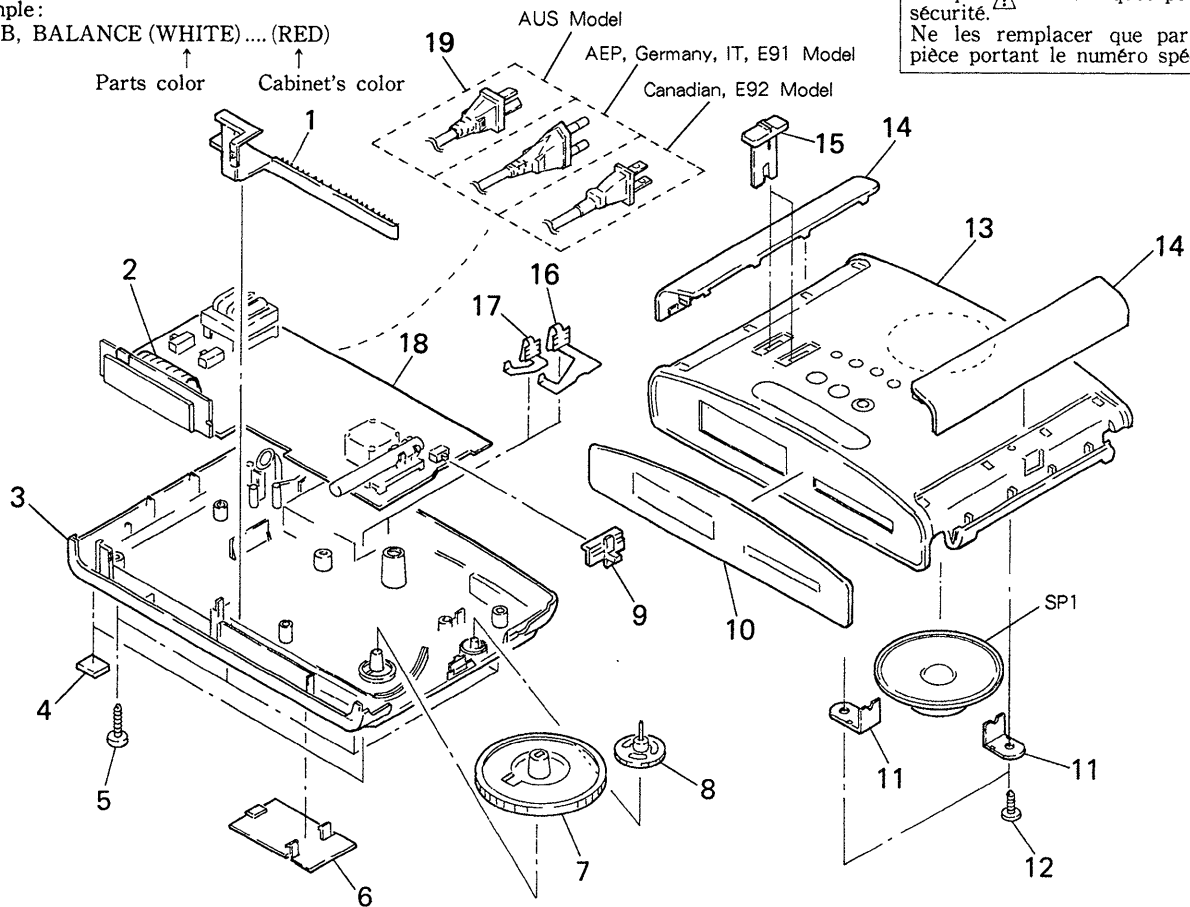
Les composants identifiés par une marque  sont critiques pour la sécurité. Ne les remplacer que par une pièce portant le numéro spécifié.



Ref. No.	Part No.	Description	Remark
1	3-369-675-01	POINTER (WHITE)--- (BLACK)	
1	3-369-675-11	POINTER (RED)--- (WHITE)	
2	1-575-159-11	CORD, CONNECTION	
3	3-369-681-11	CABINET (LOWER) (WHITE) (20:Canadian, E92)	
3	3-369-681-21	CABINET (LOWER) (BLACK) (20:Canadian, E92)	
3	3-369-681-31	CABINET (LOWER) (WHITE) (20:AUS)	
3	3-369-681-41	CABINET (LOWER) (BLACK) (20:AUS)	
3	3-369-681-71	CABINET (LOWER) (WHITE) (20:AEP, E91)	
3	3-369-681-81	CABINET (LOWER) (BLACK) (20:AEP, E91)	
3	3-374-515-01	CABINET (LOWER) (WHITE) (25:G, IT)	
3	3-374-515-11	CABINET (LOWER) (BLACK) (25:G, IT)	
4	3-368-852-01	FOOT	
5	7-685-649-79	SCREW +P 3X14 TYPE2 NON-SLIT	
6	3-369-135-11	LID, BATTERY CASE	
7	3-369-138-01	KNOB (T)	
8	3-369-134-01	KNOB (V)	
9	3-369-670-01	KNOB (BAND) (20:Canadian, E92)	
9	3-375-496-01	KNOB (3 BAND) (20:AEP, AUS, E91, 25:G, IT)	
10	3-369-673-01	PLATE, INDICATION (20:Canadian, E92)	
10	3-369-673-31	PLATE, INDICATION (20:E91, 25:G, IT)	
10	3-369-673-51	PLATE, INDICATION (20:AEP, AUS)	

Ref. No.	Part No.	Description	Remark
11	3-903-217-01	CLAW, SPEAKER	
12	7-685-647-79	SCREW +BTP 3X10 TYPE2 N-S	
13	X-3363-578-1	CABINET (UPPER) (BROWN)	
13	X-3363-727-1	CABINET (UPPER) (WHITE)	
13	X-3363-828-1	CABINET (UPPER) (BLACK) (20:Canadian, E92)	
14	3-369-674-11	PLATE, ORNAMENTAL (STONE)--- (WHITE)	
14	3-369-674-21	PLATE, ORNAMENTAL (GRAY)--- (BLACK)	
15	3-369-676-11	KNOB (ALARM) (WHITE)--- (WHITE)	
15	3-369-676-21	KNOB (ALARM) (BLACK)--- (BLACK)	
16	3-369-678-01	SPRING (BATTERY -)	
17	3-369-677-01	SPRING (BATTERY +)	
* 18	A-3661-364-A	MOUNTED PCB (HAND), MAIN (20:Canadian, E92)	
* 18	A-3661-456-A	MOUNTED PCB (HAND), MAIN (25:G, IT)	
* 18	A-3661-463-A	MOUNTED PCB (HAND), MAIN (20:AEP, E91)	
* 18	A-3661-466-A	MOUNTED PCB (HAND), MAIN (20:AUS)	
 19	1-590-930-11	CORD, POWER (20:Canadian, E92)	
 19	1-555-795-00	CORD, POWER (20:AEP, E91, 25:G, IT)	
 19	1-559-912-11	CORD, POWER (20:AUS)	
SP1	1-503-082-00	SPEAKER (6.6CM)	

SECTION 6 ELECTRICAL PARTS LIST

MAIN

NOTE:

- Due to standardization, replacements in the parts list may be different from the parts specified in the diagrams or the components used on the set.
- -XX, -X mean standardized parts, so they may have some difference from the original one.
- RESISTORS
All resistors are in ohms
METAL: Metal-film resistor
METAL OXIDE: Metal oxide-film resistor
F: nonflammable

- Items marked "*" are not stocked since they are seldom required for routine service. Some delay should be anticipated when ordering these items.
- SEMICONDUCTORS
In each case, u: μ , for example:
uA.....: μ A....., uPA.....: μ PA.....
uPB.....: μ PB....., uPC.....: μ PC.....
uPD.....: μ PD.....
- CAPACITORS
uF: μ F
- COILS
uH: μ H

The components identified by mark Δ or dotted line with mark Δ are critical for safety. Replace only with part number specified.

Les composants identifiés par une marque Δ sont critiques pour la sécurité. Ne les remplacer que par une pièce portant le numéro spécifié.

When indicating parts by reference number, please include the board.

Ref. No.	Part No.	Description	Remark
*	A-3661-364-A	MOUNTED PCB (HAND), MAIN (20:Canadian, E)	
*	A-3661-456-A	MOUNTED PCB (HAND), MAIN (25:G, IT)	
*	A-3661-463-A	MOUNTED PCB (HAND), MAIN (20:AEP)	
*	A-3661-466-A	MOUNTED PCB (HAND), MAIN (20:AUS)	

< CAPACITOR >			
C1	1-163-165-00	CERAMIC CHIP 22PF	5% 50V
C2	1-163-114-00	CERAMIC CHIP 75PF	5% 50V
C3	1-163-097-00	CERAMIC CHIP 15PF	5% 50V
C4	1-163-087-00	CERAMIC CHIP 4PF	50V
C5	1-163-165-00	CERAMIC CHIP 22PF	5% 50V (20:Canadian, E92)
C5	1-163-167-00	CERAMIC CHIP 27PF	5% 50V (20:AEP, AUS, E91, 25:G, IT)
C6	1-163-100-00	CERAMIC CHIP 20PF	5% 50V (20:Canadian, E92)
C6	1-163-104-00	CERAMIC CHIP 30PF	5% 50V (20:AEP, AUS, E91, 25:G, IT)
C7	1-102-942-00	CERAMIC 5.0PF	+-.5PF 50V
C8	1-163-059-00	CERAMIC CHIP 0.01uF	10% 50V
C9	1-124-907-11	ELECT 10uF	20% 50V
C10	1-163-031-11	CERAMIC CHIP 0.01uF	50V
C11	1-124-927-11	ELECT 4.7uF	20% 100V
C12	1-124-927-11	ELECT 4.7uF	20% 100V
C13	1-163-031-11	CERAMIC CHIP 0.01uF	50V
C14	1-163-033-00	CERAMIC CHIP 0.022uF	50V
C15	1-163-033-00	CERAMIC CHIP 0.022uF	50V
C16	1-164-182-11	CERAMIC CHIP 0.0033uF	10% 50V
C17	1-163-031-11	CERAMIC CHIP 0.01uF	50V
C18	1-163-031-11	CERAMIC CHIP 0.01uF	50V
C19	1-163-031-11	CERAMIC CHIP 0.01uF	50V
C20	1-163-031-11	CERAMIC CHIP 0.01uF	50V
C21	1-163-031-11	CERAMIC CHIP 0.01uF	50V

Ref. No.	Part No.	Description	Remark
C22	1-124-120-11	ELECT 220uF	20% 25V
C23	1-163-031-11	CERAMIC CHIP 0.01uF	50V
C24	1-163-031-11	CERAMIC CHIP 0.01uF	50V
C25	1-163-086-00	CERAMIC CHIP 3PF	50V
C26	1-163-031-11	CERAMIC CHIP 0.01uF	50V
C27	1-124-927-11	ELECT 4.7uF	20% 100V
C28	1-124-925-11	ELECT 2.2uF	20% 100V
C29	1-163-033-00	CERAMIC CHIP 0.022uF	50V
C30	1-163-038-00	CERAMIC CHIP 0.1uF	25V
C31	1-124-126-00	ELECT 47uF	20% 10V
C32	1-124-472-11	ELECT 470uF	20% 10V
C33	1-164-004-11	CERAMIC CHIP 0.1uF	10% 25V
C34	1-126-176-11	ELECT 220uF	20% 10V
C35	1-164-005-11	CERAMIC CHIP 0.47uF	25V
C36	1-163-222-11	CERAMIC CHIP 5PF	0.25PF 50V (20:Canadian, E92)
C37	1-124-126-00	ELECT 47uF	20% 10V
C38	1-163-033-00	CERAMIC CHIP 0.022uF	50V
C39	1-163-038-00	CERAMIC CHIP 0.1uF	25V
C40	1-124-472-11	ELECT 470uF	20% 10V
C41	1-126-101-11	ELECT 100uF	20% 16V
C42	1-163-077-00	CERAMIC CHIP 0.1uF	10% 25V
C43	1-163-038-00	CERAMIC CHIP 0.1uF	25V
C44	1-163-031-11	CERAMIC CHIP 0.01uF	50V

< FILTER >

CF1	1-577-072-11	FILTER, CERAMIC
CF2	1-567-097-61	FILTER, CERAMIC
CF3	1-567-097-61	FILTER, CERAMIC

< CAP, VARIABLE >

CV1	1-151-628-11	CAP, VARIABLE
-----	--------------	---------------

MAIN

Ref. No.	Part No.	Description	Remark	Ref. No.	Part No.	Description	Remark
		< DIODE >					
D4	8-719-911-19	DIODE 1SS119		R6	1-216-089-00	METAL CHIP 47K 5%	1/10W
D5	8-719-911-19	DIODE 1SS119		R7	1-216-748-11	METAL CHIP 39K 1%	1/10W
D6	8-719-911-19	DIODE 1SS119		R8	1-216-091-00	METAL CHIP 56K 5%	1/10W
D7	8-719-911-19	DIODE 1SS119		R9	1-216-079-00	METAL CHIP 18K 5%	1/10W
D8	8-719-911-19	DIODE 1SS119		R11	1-216-063-00	METAL CHIP 3.9K 5%	1/10W
D9	8-719-911-19	DIODE 1SS119		R12	1-216-063-00	METAL CHIP 3.9K 5%	1/10W
D10	8-719-911-19	DIODE 1SS119		R13	1-216-101-00	METAL CHIP 150K 5%	1/10W
D11	8-719-911-19	DIODE 1SS119		R14	1-216-258-00	METAL GLAZE 330K 5%	1/8W
D12	8-719-200-02	DIODE 10E2		R15	1-216-097-00	METAL CHIP 100K 5%	1/10W
D13	1-808-342-11	DIODE SL1042-78T (20:Canadian, E92, AUS)		R16	1-216-097-00	METAL CHIP 100K 5%	1/10W
D13	1-808-344-11	DIODE SL1042-79T (20:AEP, E91)		R17	1-216-049-00	METAL CHIP 1K 5%	1/10W
D13	1-808-653-21	LED BLOCK (GREEN LED) (25:G, IT)		R18	1-216-049-00	METAL CHIP 1K 5%	1/10W
		< IC >		R19	1-216-089-00	METAL CHIP 47K 5%	1/10W
IC1	8-752-035-29	IC CXA1019S		R20	1-216-073-00	METAL CHIP 10K 5%	1/10W
IC2	8-759-823-50	IC LM8562		R21	1-216-073-00	METAL CHIP 10K 5%	1/10W
		< JACK >		R22	1-216-089-00	METAL CHIP 47K 5%	1/10W
J1	1-216-295-00	METAL CHIP 0 5% 1/10W		R23	1-216-097-00	METAL CHIP 100K 5%	1/10W
J2	1-216-296-00	METAL CHIP 0 5% 1/8W		R24	1-216-121-00	METAL CHIP 1M 5%	1/10W
J3	1-216-295-00	METAL CHIP 0 5% 1/10W		R25	1-216-049-00	METAL CHIP 1K 5%	1/10W
J4	1-216-295-00	METAL CHIP 0 5% 1/10W (20:Canadian, E92)		R26	1-216-089-00	METAL CHIP 47K 5%	1/10W
J5	1-216-296-00	METAL CHIP 0 5% 1/8W		R27	1-216-009-00	METAL CHIP 22 5%	1/10W
J6	1-216-296-00	METAL CHIP 0 5% 1/8W		R31	1-216-049-00	METAL CHIP 1K 5%	1/10W
J11	1-216-295-00	METAL CHIP 0 5% 1/10W (20:AEP, AUS, 25:G, IT)		R32	1-216-089-00	METAL CHIP 47K 5%	1/10W
		< COIL >		R33	1-216-097-00	METAL CHIP 100K 5%	1/10W
L3	1-402-464-11	ANTENNA, FERRITE-ROD (MW)		R35	1-216-079-00	METAL CHIP 18K 5%	1/10W
* L5	1-422-300-11	COIL, AIR-CORE (20:Canadian, E92)		R36	1-216-073-00	METAL CHIP 10K 5%	1/10W
L5	1-459-815-11	COIL (WITH CORE) (20:AEP, AUS, E91, 25:G, IT)		R37	1-216-238-00	METAL GLAZE 47K 5%	1/8W
L6	1-406-028-00	COIL, OSC (MW)		R39	1-216-059-00	METAL CHIP 2.7K 5%	1/10W (20:AEP, AUS, E91, 25:G, IT)
		< TRANSISTOR >				< VARIABLE RESISTOR >	
Q1	8-729-920-68	TRANSISTOR 2SA933S-QR		RV1	1-228-790-00	RES, VAR, CARBON 50K (VOL)	
Q2	8-729-142-46	TRANSISTOR 2SC2001-LK				< SWITCH >	
Q3	8-729-119-78	TRANSISTOR 2SC2785-HFE		S1	1-571-478-11	SWITCH, SLIDE (BAND)	
Q4	8-729-920-68	TRANSISTOR 2SA933S-QR		S2	1-572-762-11	SWITCH, SLIDE (ALARM A)	
		< RESISTOR >		S3	1-572-762-11	SWITCH, SLIDE (ALARM B)	
R1	1-216-049-00	METAL CHIP 1K 5% 1/10W		S4	1-554-937-11	SWITCH, KEY BOARD (TIME SET ALARM A)	
R2	1-216-057-00	METAL CHIP 2.2K 5% 1/10W		S5	1-554-937-11	SWITCH, KEY BOARD (TIME SET ALARM B)	
R3	1-216-089-00	METAL CHIP 47K 5% 1/10W		S6	1-554-937-11	SWITCH, KEY BOARD (TIME SET -)	
R4	1-216-025-00	METAL CHIP 100 5% 1/10W		S7	1-554-937-11	SWITCH, KEY BOARD (TIME SET +)	
R5	1-216-071-00	METAL CHIP 8.2K 5% 1/10W		S8	1-554-937-11	SWITCH, KEY BOARD (CLOCK)	
				S9	1-554-937-11	SWITCH, KEY BOARD (ALARM RESET, RADIO OFF)	
				S10	1-554-937-11	SWITCH, KEY BOARD (RADIO ON)	
				S11	1-554-937-11	SWITCH, KEY BOARD (REPEAT ALARM)	
				S12	1-554-937-11	SWITCH, KEY BOARD (SLEEP)	

MAIN

Ref. No.	Part No.	Description	Remark
----------	----------	-------------	--------

< TRANSFORMER >

T1	1-404-790-11	TRANSFORMER, IF	
----	--------------	-----------------	--

△T2	1-449-801-21	TRANSFORMER, POWER (20:Canadian, E92)	
-----	--------------	---------------------------------------	--

△T2	1-449-940-11	TRANSFORMER, POWER (20:AEP, AUS, E91, 25:G, IT)	
-----	--------------	--	--

< TERMINAL >

* TML1	1-535-771-11	TERMINAL (20:AEP, AUS, E91, 25:G, IT)	
--------	--------------	---------------------------------------	--

* TML2	1-535-771-11	TERMINAL (20:AEP, AUS, E91, 25:G, IT)	
--------	--------------	---------------------------------------	--

MISCELLANEOUS

2	1-575-159-11	CORD, CONNECTION	
---	--------------	------------------	--

△19	1-555-795-00	CORD, POWER (20:AEP, E91, 25:G, IT)	
-----	--------------	-------------------------------------	--

△19	1-559-912-11	CORD, POWER (20:AUS)	
-----	--------------	----------------------	--

△19	1-590-930-11	CORD, POWER (20:Canadian, E92)	
-----	--------------	--------------------------------	--

SP1	1-503-082-00	SPEAKER (6.6CM)	
-----	--------------	-----------------	--

ACCESSORIES & PACKING MATERIALS

*	3-372-873-01	INDIVIDUAL CARTON (20:Canadian, E92)	
---	--------------	--------------------------------------	--

*	3-373-022-01	INDIVIDUAL CARTON (20:AEP, AUS, E91)	
---	--------------	--------------------------------------	--

*	3-373-023-01	INDIVIDUAL CARTON (25:G, IT)	
---	--------------	------------------------------	--



*	3-704-282-01	BAG (STANDARD), PROTECTION	
---	--------------	----------------------------	--

3-753-775-11	MANUAL, INSTRUCTION (ENGLISH, FRENCH, GERMAN, DUTCH, ITALIAN) (20:AEP, AUS, E91, 25:G, IT)	
--------------	---	--

3-753-775-31	MANUAL, INSTRUCTION (ENGLISH, FRENCH) (20:Canadian, E92)	
--------------	---	--

3-753-775-41	MANUAL, INSTRUCTION (SPANISH, SWEDISH, PORTUGUESE) (20:AEP)	
--------------	--	--

Note:

The components identified by mark  or dotted line with mark  are critical for safety. Replace only with part number specified.

Note:

Les composants identifiés par une marque  sont critiques pour la sécurité. Ne les remplacer que par une pièce portant le numéro spécifié.