

**ÖKO\_LAVAMAT 675**

**sensortronic**

**The Environment-Friendly Washing Machine**

**Operating Instructions**

## Hello

Allow me to introduce myself: I am your AEG ÖKO-LAVAMAT environment-friendly automatic washing machine. From now on, I should like to make washing easier for you, not simply because of my attractive appearance, but also thanks to my "intrinsic qualities". I am economical in terms of energy, water, and detergent consumption, especially quiet in operation, easy to operate, and simple to care for.

**If you carefully read and follow my operating instructions before first use and familiarise yourself with my installation and connection instructions, you are sure to experience a good deal of joy when using me to wash your laundry!**

**You must read these instructions prior to using the appliance and retain them for future reference.**



# Contents

<b>Safety instructions</b>	
Before first use	4
For the user	4/5
You should also note the following	5
<b>The ÖKO system</b>	6/7
<b>Out of concern for the environment . . .</b>	
ÖKO tips for economical washing	8
The economy programmes	8
<b>Appliance description</b>	
Features	9-11
<b>Brief instructions on machine washing</b>	12
<b>Before starting to wash</b>	
Sorting your laundry	13
Pretreating your laundry	14
Care needed for certain fabrics	14
<b>Loading the laundry</b>	
Recommended wash loads	15
Open loading doors	16
Loading laundry	16
Close loading doors	16
<b>Detergents</b>	
Select detergent	17
Amount of detergent	17
Adding detergent	18
<b>Selecting the wash programme</b>	
Programme selector/programme cycle indicator/ Temperature selector	19/20
<b>Programme tables</b>	24/25
<b>Consumption values</b>	26
<b>Programme end</b>	27
<b>Additional rinse</b>	28
<b>Special accessories</b>	29
<b>Cleaning, maintenance, care</b>	30/31
<b>If you think your washing machine is not working properly . . .</b>	32-36
<b>Customer service</b>	37
<b>Technical data</b>	38

## Safety instructions

### Before first use . . .

- Please note my installation and connection instructions.
- Please ensure you have removed all my transport packing. Unless removed, transport packing will cause damage to the appliance and adjacent furniture during spinning.
- You should run an initial wash cycle without laundry to remove residues of factory-applied grease from the drum and tub. Programme: 60 °C cotton programme with half a beaker of detergent.

You may find small water residues in my tub, these are due to the thorough testing which your machine was subjected to in the factory.

### Safety instructions for the user

AEG electrical appliances conform to the recognised safety regulations governing electrical domestic appliances. As manufacturers, we nonetheless feel obliged to familiarise you and any other persons using the machine with the following instructions:

- Please make sure before using your machine for the first time that the mains voltage and supply indicated on my rating plate agree with the mains voltage where the machine is to be used. The fuse required is indicated on the rating plate.
- Before cleaning, care and maintenance work, make sure that the appliance is switched off. We advise for safety reasons that you pull the mains plug out of the socket, switch off at the power point or completely remove the fuse in the fuse box servicing this circuit. (See installation and connection instructions.)
- Never direct a water jet onto my outer casing!
- Never use my supply lead to pull the mains plug out of the socket!
- Never operate me if:
  - my mains supply lead is damaged, or
  - the appliance shows visible damage to the control panel, worktop, or plinth.
- **Repairs to electrical appliances should only be performed by a trained electrician. Improper repairs may place the user at serious risk.**

If any other maintenance needs to be carried out, you are recommended to contact our service centre or AEG authorised service agents. Only original AEG spare parts fulfill all requirements!

- If I am installed under a worktop in your kitchen or utility room, i.e. my worktop has been removed, an earthed cover plate must be fitted as protection against contact according to the installation and connection instructions. (See special accessories.)
- Children may not recognise the dangers of improper use of electrical appliances. Therefore, please ensure proper supervision during use.

- When the day finally comes to withdraw me from service and to replace me with another machine, please make sure that you inactivate my door lock and cut my electrical supply lead, disposing of lead and plug safely. This will prevent children from locking themselves in, thus endangering their lives. Ensure safe disposal of the appliance.
  - If I am incorrectly operated or used for any purpose other than that for which I am intended, AEG cannot assume liability for any possible damage.
  - Do not climb on the appliance.
  - Keep small children from climbing into the machine to play hide and seek.
  - Do not reach into the moving drum.
  - When you wash with high temperatures, the glass of the loading door will become hot. Do not touch!
  - If appliance is opened by force or through the emergency drain during operation, very hot water can result in scalding.
  - In case of faults, switch the appliance off, remove the plug from the socket and turn the water supply to the machine off.
- 
- Please keep my packaging away from children. The foil represents a particular danger. The packaging material meets ecological requirements and can be easily disposed of. You are advised to do this as quickly as possible.
  - If the machine is not permanently connected: hook my drain hose securely over the edge of the sink using the hose holder provided. (See section on "Water drainage" in the installation and connection instructions.)
  - If your laundry has been pre-cleaned with flammable solvents, these solvents must have fully evaporated before placing the laundry in the machine.
  - Never use me for chemical cleaning!
  - Dyes/dye removal agents may only be used if the manufacturer of these products expressly allows them to be used in automatic washing machines. Please see their instructions for use. No liability can be assumed for any consequential damage.
  - When cleaning my stainless steel drum, never use any iron-containing scouring agents or steel wool!  
Keep furniture polishes or abrasive cleaners away from my control panel and my controls.  
Only use tap water. Never use any other liquids. You may use rainwater only if it is completely clean, otherwise operation of my electrical solenoid valves could be impaired.

**You should also note the following . . .**

# My ÖKO System



Your new ÖKO-LAVAMAT meets all laundry care requirements and allows individual and versatile programme selection. It is highly economical in water, energy and detergent consumption, which not only contributes to the protection of our environment, but also save you money.

## The Sensor-tronic System

This rinse-spin development reduces sudsing in the cotton/linen programmes during the intermediate spinning cycles. Each spin cycle is started at a slow spin speed during which the **suds are monitored**. The process is fully automatic and can be recognised by the frequent change in the spin speeds. The benefit to you is an optimum rinsing result while saving considerable amounts of water.

**The machine uses only 68 litres of water for a main wash programme, without prewash.**

In case too much detergent has been used, the machine automatically introduces an additional rinse (see programme sequence indicator), which increases the overall water consumption somewhat.

## The ÖKO Lock

My ÖKO lock ensures 100% effective detergent utilisation. The ÖKO valve closes off the wash tub from the drainage system during all wash programmes. This not only reinforces the cleaning effect but also saves detergent – a saving of 20% in comparison to machines without such a device.

## The Stream Clean

The special AEG wash paddles carefully scoop up the wash solution, and on reaching the top of the drum, gently spray streams of water through your wash load. This system ensures that your laundry is at all times soaked in the wash solution.

## The Automatic Flowrate Feature

The automatic flowrate feature automatically adjusts the water consumption to the wash load and fabric type concerned. By additionally pressing the ½ load button for small wash loads, you can save even more water.

For lightly soiled and small wash loads, eg in the case of sports and leisure clothing, use the short programmes.

My wool cradle takes special care of your woollens: with a very gentle washing action, these especially sensitive garments are gently "rocked" to and fro in the drum.

The packaging material meets ecological requirements and can be easily disposed of or can be burned safely in the municipal incinerators.

To the materials: the plastics can be recycled and are marked as follows:

> **PE** < for Polyethylene, e.g. the outer wrapping and the bags inside.

> **PS** < for blown (CFC free) Polystyrene, e.g. the fillers

The cardboard parts have been manufactured from recycled material and should be taken for recycling again.

## **The Short Programmes**

## **The Wool Cradle**

## **Information on the packaging material of the appliance**

## Out of concern for the environment . . .



### ÖKO Tips for Economical Washing

These hints are intended to help you act in an environmentally conscious manner.

- For normally soiled laundry, the programmes are intended for use without prewash. Compared to a programme with prewash, you save detergent and water.
- It is more economical to wash full loads. If you find it necessary to wash small loads, you should use my  button. Add only  $\frac{2}{3}$  to  $\frac{1}{2}$  of the amount of detergent for a full load. This will result in consumption of less water, energy and detergent.
- For light to normally soiled laundry, it is often sufficient to use my economy programme, ie at a lower temperature for a longer time.
- With suitable pretreatment, stains and limited soiling can be removed. This saves a programme being used for heavily soiled laundry.
- Dose your detergent exactly as instructed by the detergent manufacturer, bearing in mind that because of the ÖKO lock you can use 20% less. Overdosage wastes money and burdens the environment. You should also note the instructions for lightly soiled laundry.
- Detergent savings and care for the environment can also be achieved by dosing the detergent as for soft water although you have medium to high water hardnesses, and additionally adding a water softener. This reduces the amount of "chemicals" entering our water ways.
- Use fabric softeners only where necessary, eg for synthetic or mixed fabrics, to avoid static. If you use a tumble dryer, your laundry will be soft and fluffy without a fabric softener.

### Economy Programmes

**Here are my economy programmes:**

-  – Programmes for half and small wash loads
-  – Programmes for fabrics where soiling does not require the full programme at a high temperature



## Appliance description

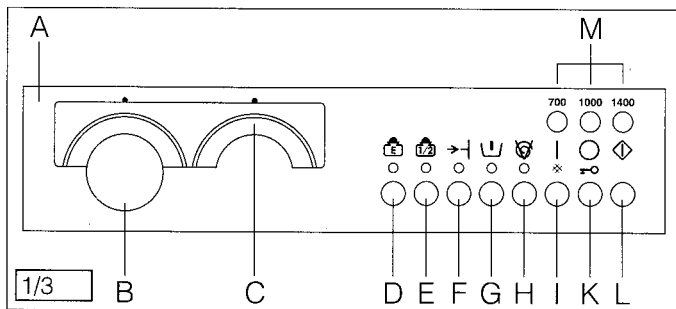

- A** Control panel
- B** 17-setting programme selector
- C** Programme cycle indicator
- D** Energy-saving or intensive washing button
- E** Small wash load button
- F** Short programme button
- G** Prewash programme button
- H** VARIOMATIC spin and rinse-hold cancel button
- I** ON button with operating pilot lamp (red) above
- K** Door release/OFF button  
(automatically releases button D to H)
- L** Start button
- M** Spin speed selector buttons

## Features

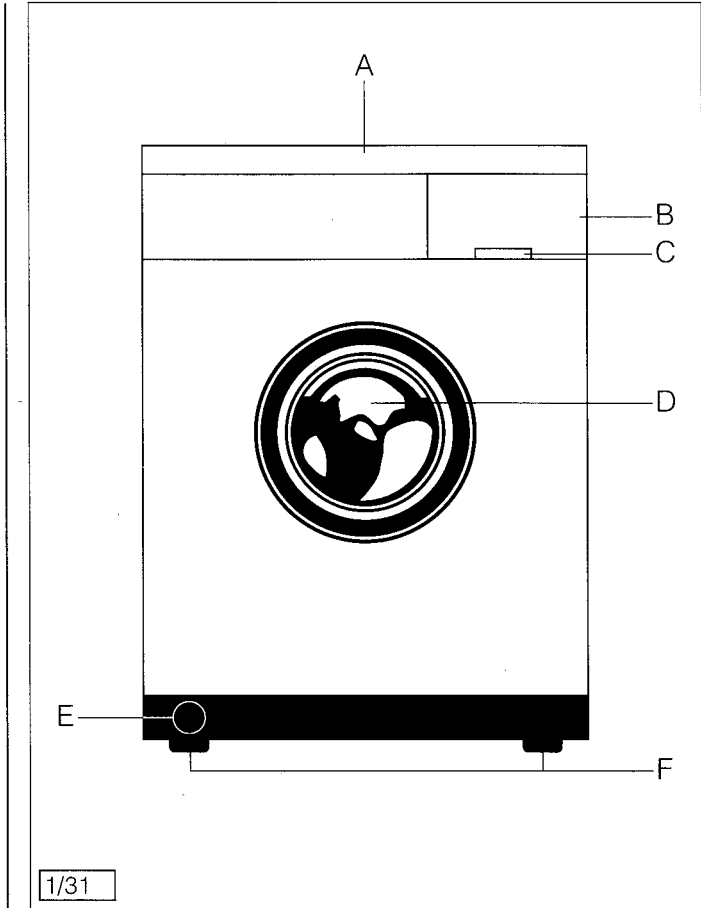

1/31

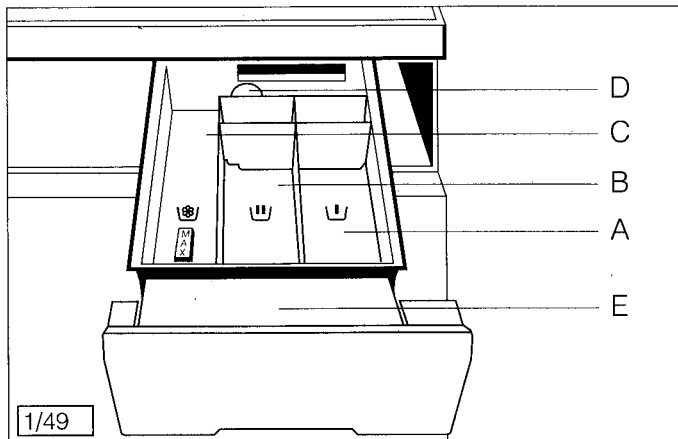

1/49

- A** Removable worktop
- B** Dispenser with compartments for detergent and fabric conditioner and with removable programme card printed on both sides
- C** Detergent dispenser handle
- D** Laundry loading door, opened via door release/OFF button (only when machine is connected to electricity)
- E** Drain pump (cover with debris trap opens for cleaning) – on LH side of pump cover, emergency drain hose and rotary release knob for emergency release of loading door
- F** 4 height-adjustable screw-in feet (front and rear)

## Features

- 
- A** Prewash detergent compartment
  - B** Detergent compartment for main wash
  - C** Liquid conditioner compartment (fabric softener, liquid conditioner, starch)
  - D** Siphon (must be securely inserted)
  - E** Programme card\*)

\*) You can re-order my programme card from your service centre if it ever gets lost.

## The dispenser for detergent and fabric conditioner

## Brief instructions on machine washing

### Preparing the laundry

Sorting  
Pretreatment  
Care needed for certain fabrics

### Loading the laundry

Open loading doors  
Distribute laundry in the drum  
Close doors

### Detergent dosage

Select detergent  
Measure amount of detergent  
Add detergent/fabric conditioner  
Close dispenser

### Selecting the wash programme

See programme table or programme card in dispenser  
Select programme  
Press option buttons  
Press ON button  
The programme starts. The pilot lamp lights up.

### Continuing the programme

On programmes with rinse-hold , to drain water from laundry:  
Set programme selector to F or H – see programme tables.

### When the programme has finished

Press the door release/OFF button until the loading door springs open; any depressed programme buttons are automatically released. The pilot lamp goes out.  
Take out the laundry.  
If no more laundry is to be washed:  
Turn the programme selectors to the OFF position.

# Before starting to wash

## Sorting your laundry

- Check that the fabrics are machine-washable. The international care labels will give you guidance.
- Woollens labelled only with the woolmark  are **not** suitable for machine-washing. Also garments marked with the following symbols:

**Hand wash**



**Do not wash**



Sort your laundry into laundry types as follows, separating coloureds from whites.:

**Cotton/linen – Whites**



**Cotton/linen – Coloureds**



**Easy-care fabrics**



**Delicates**



**Woollens**



- Woollens must be labelled with the woolmark and additionally marked “will not felt”, “non-felting”, or “machine-washable”.
- Coloureds and whites should never be washed together, whites will turn grey.  
New dark coloured laundry will often state “wash separately”. This type of garment will often have surplus colour which may be transferred to lighter fabrics during washing. Always wash such items on their own for the first few washes.
- You may also see the following labels. They are not common in the UK, but are widely used in garments manufactured in the rest of Europe.

**White cotton articles with special finishes**

**White nylon and white polyester cotton**

**This label may be found in a variety of garments – the articles should be laundered on the wool programme.**

## Before starting to wash

### Pretreating your laundry

- Wherever possible remove **stains** immediately, before they have set, with water and soap or with a special pretreatment agent (spray, liquid detergent).

### Care needed for Certain Fabrics

#### ■ Empty pockets

Please make sure that no metal objects (eg paper clips, staples, coins, safety pins, or the like) remain in the laundry.

Button up pillow cases, close zip-fasteners, hooks and eyes. Tie together loose belts and long apron strings.

Turn coloured knitted garments, woolens, or bejewelled textiles inside out.

- **Particularly small or sensitive garments** (eg baby socks, ladies tights, etc) should be washed in a launder net bag or pillowcase.

#### ■ Handle curtains especially carefully

Remove rings and hooks from your curtains, to avoid damage or tearing. Synthetic curtains should be handled carefully as they snag easily. Place net curtains in a pillowcase or wash bag.

Under no circumstances can we accept liability for damage to curtains through incorrect handling.

Spin curtains only when permitted by the manufacturer.

## Loading your laundry

	Full load	Small loads
Cotton/linen – Whites/coloureds normally soiled	5.0 kg	2.5 kg
heavily soiled	3.5 kg	1.8 kg
Easy-care fabrics and delicates	2.0 kg	1.0 kg
Woollens	1.0 kg	–
Short programme for whites/coloureds	2.5 kg	1.3 kg
Short programme for easy-care fabrics	2.0 kg	1.0 kg

Use the recommended full load wherever possible, as this is the most economical way to wash.

But do not overload!

This will adversely affect the wash result. When washing easy-care fabrics susceptible to creasing, reduce the load.

**Wash loads  
(maximum dry  
loads)**

**Opening and closing the loading door**  
**To open:**

At the end of the programme press the door release OFF button  until the door springs open.

**To open the loading door in the event of a power failure**

See "If you think your washing machine is not working properly ..."

**To open the loading door when it is not connected**

- Turn rotary control for emergency drain (A) a quarter turn **anti-clockwise** to the stop position.
- Using a coin turn disc (C) **anti-clockwise** until the loading door springs open.

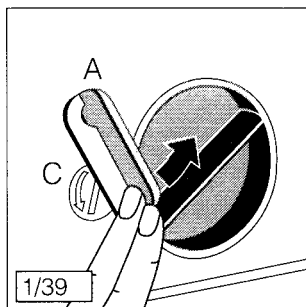

- Turn rotary control for emergency drain (A) in clockwise direction.

**Loading**

Loosely load your unfolded laundry in to the drum, mixing small and large items as much as possible. This reinforces the washing action and promotes even distribution of the laundry during spinning.

**To close:**

Press the door closed so that the catch clicks into position.

**Safety lock**

For your safety, my loading door is locked throughout the programme cycle. It can be immediately opened once the programme has finished.



# Detergents

Use only detergents that are suitable for automatic washing machines.

You will achieve the best cleaning results with minimum harm to the environment by also considering the type of laundry soiling when selecting a suitable detergent.

Machine-washable soiling is basically classified as:

- **Dirt**, e. g. dust, soot, sweat, grease, etc.
- **Stains**, e. g. tea, red wine, fruit, blood

You will find BIO and NONBIOLOGICAL detergents in powder or liquid forms. Check with the detergent manufacturers information as to which detergent suits your purposes best bearing in mind that the detergent must be a low lather one suitable for automatic washing machines! **We recommend ARIEL (in the various different forms) and Dreft automatic for woollens.**

- **Water softeners** allow the use of smaller amounts of detergents in households having medium-hard to very hard tap water.
- **Fabric softeners** prevent the static charging of synthetic fabrics and make your laundry soft to the touch. If you use a tumble dryer, your laundry will be soft and fluffy without a fabric conditioner. We recommend LENOR fabric conditioner.
- **Starches, conditioning rinses**, ensure that your laundry keeps its shape.

The amount of detergent used depends on the hardness range of your tap water. With an increasing water hardness, more detergent must be dosed to bind the lime contained in the water. You will find dosage indications for soft or hard water on the detergent pack. For lightly soiled laundry, use less detergent. Follow the detergent manufacturers instructions. If the latter gives no dosage indications for small loads, you should reduce by  $\frac{1}{3}$  for half wash loads and for even smaller loads use  $\frac{1}{2}$  the amount recommended for a full load. You can save detergent and prevent unnecessary amounts of detergent from entering our waterways by using a special water softener in areas with hard water.

You should dose the special softener depending on the water hardness as instructed on the softener package. In this case, you should **always dose the detergent for "soft" water** as instructed on the detergent packages.

In this case, add the detergent and softener **together** in the main wash compartment. When using programmes with prewash, add it to the respective compartments for prewash and main wash.

## Selecting your detergent

## Detergents

## Washing aids

## Amount of detergent

## Dosing the detergent

The detergent dispenser has three compartments:

Compartment (right)  = washing powder for programmes **with prewash**

Compartment (centre)  = washing powder for main wash

Compartment (left)  = liquid conditioner (conditioning rinse, starch)

### Please also note the following:

#### Dosing powders

- When adding detergent and water softener, fill **first detergent and then softener** in the same compartments.
- Stain salts/bleaching agents are always filled on the detergent.

#### Dosing liquids

- If you prefer **liquid detergents**, dose these agents as instructed by the detergent manufacturer, using the “balls” supplied or offered by the detergent manufacturer.
- When using liquid, follow the manufacturers's instructions.

#### Dosing fabric conditioners

- **Do not fill above “MAX”** indicator level as otherwise the liquid may drain immediately.
- **When using thick concentrated fabric conditioner and starches**, you are recommended to mix the concentrate with water to ensure troublefree dispensing.
- If you want to use **starch powder**, dissolve according to the manufacturers's instructions and place in compartment , selecting the “Fabric conditioning – Starching” programme.

# Selecting the wash programme

Select my laundry programmes with the programme selector (fig. 1/3 B) and buttons (fig. 1/3 D to M).

For normally soiled laundry, select a programme without prewash. For heavier soiling, select a programme with a prewash **U** or an intensive wash **E** (see button functions). To remove protein stains (blood, cocoa), we recommend you use a programme **with prewash** to prevent these stains from setting. For stained laundry (fruit, vegetables, tea), select the **intensive wash** programme.

My programme selector has 14 settings for the main and additional programmes including a fast advance to correct wrongly made selections. The optimum temperature for the different fabrics is incorporated in the programmes.

If you wash at high temperatures, the loading door window gets hot. Do not touch it!

The programme selector can be turned to the left or right to the programme required.

## The programme selector

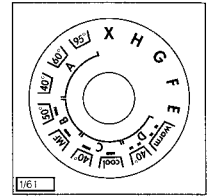



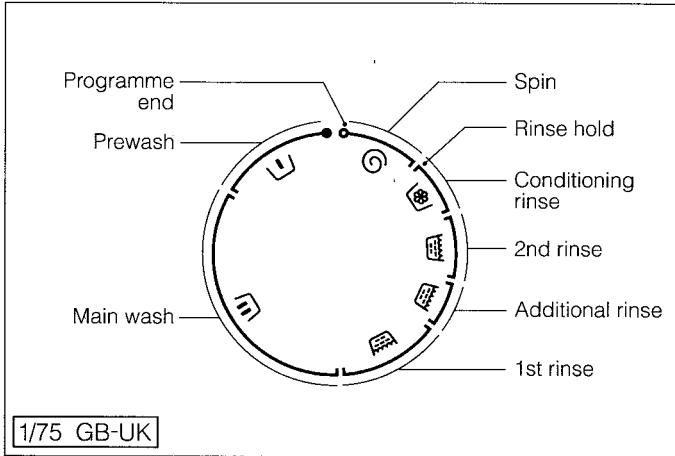

## The programme cycle indicator

During the programme, the programme cycle indicator (fig. 1/3 C) rotates step by step below the window indicating which part of the programme has been reached.

At certain stages in the programme – the programme cycle indicator will remain stationary for some time. This is particularly noticeable on the “woollens” programme.



## Symbols on programme cycle indicator

-  = Prewash
-  = Main wash
-  = Rins
-  = Conditioning rinse
-  = Spin

By combining the main and additional programmes with my buttons, you will have a range of programmes meeting all your laundry requirements.

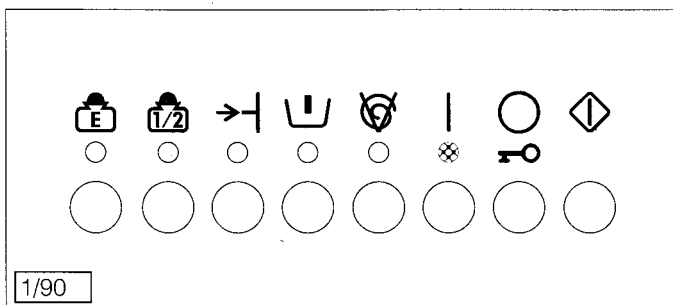

When the buttons are pressed, a red indicator appears in the display above.

Effect:

The length of time for the main wash is prolonged.

- **When washing light to normally soiled laundry**, you can save up to 30% energy due to the lower temperature (temperature: setting **60** instead of **95**).
- **When washing normally to heavily soiled laundry**, you achieve a more intensive wash without any temperature reduction.

Effect:

- **For cotton/linens and easy-care laundry**  
Reduced water level during rinsing (water saving).
- **For delicates**  
Reduced water level during washing and rinsing (water and energy saving).

This button has no effect for woollens.

It makes sense to press both **E** and **1/2** buttons together when you want to wash small loads either intensively or energy saving.

## The button functions

### Energy-saving or intensive washing



### Small wash loads



### Energy-saving or intensive washing of small wash loads



## Short wash



When washing cotton/linens and easy-care laundry, you can select a short programme appropriate for these fabrics.

Especially suitable for lightly soiled items, e.g. sports and leisure clothing, guest towels, etc.

Effect:

### ■ For cotton/linens

Shortened main wash – only 2 rinse cycles – final spin.

### ■ For easy-care fabrics

Shortened main wash – only 2 rinse cycles – rinse-hold (unless the  button has been additionally pressed).

This button can also be combined with the  button for small wash loads (see programme table).

This button has no effect in the delicates and woollens programmes.

## Pre-wash



Effect:

A pre-wash precedes the main wash for very heavily soiled laundry.

## Variomatic spinning Rinse-hold cancel



Effect:

### ■ For cotton/linens

Press this button if you want a VARIOMATIC spin instead of the normal spin. The VARIOMATIC spin is a sequence of spins with loosening of the laundry in between each spin. This reduces tangling and creasing of the laundry.

The time is prolonged by approx. 20 minutes.

### ■ For easy-care fabrics/delicates

The usual rinse-hold is cancelled, followed by a three-stage VARIOMATIC spin (**short VARIOMATIC**).

### ■ For woollens

The usual rinse-hold is cancelled, followed by a **woollens single-stage spin sequence**.

## Selecting the spin speed

700 1000 1400



Using these buttons, you can select the appropriate spin speed for your laundry.

If you press none of these buttons, your laundry is automatically spun at the maximum speed.

**Select maximum speed if this sequence is to be followed by drying in a tumble dryer as both time and energy will be saved.**

For **easy-care fabrics and delicates**, the spin speed is **limited to max. 850 rpm**. You can reduce to a speed of 700 rpm.

**Woollens** are automatically subjected to a **short spin sequence**.

**Effect:**

The machine is switched on, and the operating indicator lamp above the button lights up.

**Effect:**

The programme starts and the programme stage indicator starts to advance.

**Effect:**

Press until the door springs open.

The operating indicator lamp goes out. Your automatic washing machine is switched off, with all depressed programme buttons then being released.

Only the spin selector buttons remain depressed.

**Switching on**











**Programme start**















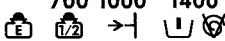







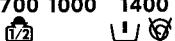
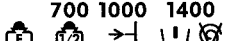
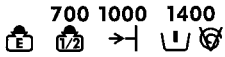
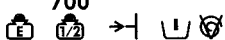
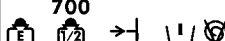

**Opening the door – switching off**



# Programme table

Care label Laundry	Pro- gramme	Wash load	Programme setting Pro- gramme selector	But- tons
-	Quick advance	-	X	◊
 Cotton/linen	Whites/ coloureds	up to 5 kg <sup>1)</sup>	<b>A</b> <sup>2)</sup>	◊
	Energy-saving programme 	up to 5 kg <sup>1)</sup>	<b>A</b> <sup>2)</sup>	   ◊
 Cotton/linen	colourfast to 	up to 5 kg <sup>1)</sup>	<b>A</b> <sup>2)</sup>	◊
	colourfast to 		<b>A</b> <sup>2)</sup>	◊
 Cotton with special finishes mixed cotton fabrics, i.e. polyester/ cotton, synthetics	Easy-care	up to 2 kg	<b>B</b> <sup>2)</sup>	◊
Any of the above Lightly soiled	Multi-fabric	up to 2 kg	<b>B</b> <sup>2)</sup>	◊
 Synthetics/curtains	Delicates Acrylics	up to 2 kg	<b>C</b> <sup>2)</sup>	◊
	Lightly soiled		<b>C</b> <sup>2)</sup>	◊
 Woollens/ mixed woollens	Woollens 	up to 1 kg	<b>D</b>	◊
	Lightly soiled		<b>D</b>	◊
Cotton/linen	Spin	up to 5 kg	<b>F</b>	◊
Easy-care/delicates		up to 2 kg	<b>G</b>	◊
	Extra prewash – soak 	up to 3.5 kg	<b>E</b>	   ◊
	Pumping out		<b>H</b>	



Programme cycle	Possible additional buttons	Instructions
Quick advance through the different programme stages. In case of wrongly selected programme advance to the beginning and re-select new programme		<p>The steps which you must take before each programme are given in the "Brief instructions".</p> <ol style="list-style-type: none"> <li>1) 3.5 kg for heavily soiled laundry</li> <li>2) With prewash </li> </ol> <p> = On button</p> <p> = Rinse-hold</p>
Main wash – intermediate spin – 3 rinses with intermediate spinning – final spin	<p><b>700 1000 1400</b></p> 	<p>The laundry remains in the last rinse water or in the soaking solution. Unless you have pressed the  button, you must pump out or spin your laundry.</p> <p><b>To use the separate soft rinsing or starching facility:</b></p> <ol style="list-style-type: none"> <li>1) Advance machine to the beginning of the soft-rinsing stage using setting X on the programme selector.</li> <li>2) Stop machine at this stage by pressing button , continue by making the following selection:               <ol style="list-style-type: none"> <li>a) For cotton/linen select programme A  and start the machine by pressing button  (1 rinse and long spin).</li> <li>b) For easy-care fabrics and delicates select programme C  and start the machine by pressing button  (1 rinse and rinse hold*). In both cases the VARIO-MATIC spin button  can be pressed. Also any spin speed reduction buttons.</li> </ol> </li> </ol>
	<p><b>700 1000 1400</b></p> 	
	<p><b>700 1000 1400</b></p> 	
	<p><b>700 1000 1400</b></p> 	
Main wash – 3 rinses – rinse-hold	<p><b>700</b></p> 	
Main wash – 3 rinses – rinse-hold	<p><b>700</b></p> 	
Main wash at high water level, reduced drum action – 3 rinses – rinse-hold	<p><b>700</b></p> 	<ol style="list-style-type: none"> <li>b) For easy-care fabrics and delicates select programme C  and start the machine by pressing button  (1 rinse and rinse hold*).</li> </ol> <p>In both cases the VARIO-MATIC spin button  can be pressed. Also any spin speed reduction buttons.</p>
	<p><b>700</b></p> 	
Main wash at high water level, reduced drum action – 3 rinses – rinse-hold	<p><b>700</b></p> 	<p><b>To use the spin only facility for hand washed and rinsed woollens proceed as follows:</b></p> <ol style="list-style-type: none"> <li>1) Advance machine to the beginning of the spinning phase using setting X on the programme selector.</li> <li>2) Stop machine at this stage by pressing button . Continue by making the following selection:               <ol style="list-style-type: none"> <li>a) Select programme D , press buttons  and . The machine carries out a specific spin designed for woollens.</li> </ol> </li> </ol>
	<p><b>700</b></p> 	
Pumping out – final spin	<p><b>700 1000 1400</b></p>	
Pumping out – short Variomatic spin	<p><b>700</b></p>	
Extra prewash or soak programme at high water level  . The laundry can remain in the detergent solution for any length of time as it is periodically agitated for a few seconds.		
Pumping out, e.g. after rinse-hold		

**Consumption Values**  
**Energy, water and time for programmes**  
**listed below (cold water connection)**

Programme	Water (litres)	Energy (kWh)	Time (minutes)
Cotton/linen 95 °C, full load	68	1.9	115
Cotton/linen 95 °C with half load button, half load	43	1.4	105
Energy saving programme, full load	68	1.4	115
Cotton/linen 60 °C, full load	68	1.0	90
Cotton/linen 40 °C, short, half load	66	0.4	40
Easy-care fabrics 50 °C, 2 kg load	62	0.7	60
Easy-care fabrics 30 °C, with half load button, short, 1 kg load	32	0.2	25
Delicates 40 °C, 2 kg	62	0.6	50
Wool 40 °C, 1 kg load	64	0.5	60

The above values were established with standard test loads. These values can vary up or down with normal household loads. The energy consumption and in some cases the time values will be lower on a hot and cold fill connection. Programmes with prewash (except for wool) will take approximately 20 minutes longer.

## Programme end

As soon as the programme has ended, press the door release/OFF button until the loading door springs open. The operating pilot lamp goes out. Your machine is switched off. All depressed programme buttons are then released. Only the selected spin speed button remains depressed. Reset where necessary to the maximum speed.

Take out the laundry.

Check that my drum is completely empty, otherwise fabrics may be damaged during the next wash (e.g. shrink) or discolour other laundry.

**Open the door –  
Switch off  
your machine**

## Additional rinse

Your ÖKO-LAVAMAT is designed for extremely economical water consumption under normal circumstances and operates with only 3 rinse cycles.

### Adding a 4th rinse

For cotton/linens, however, you can add a fourth rinse (for example if someone in your household has problem skin). See also programme cycle indicator.

The water consumption increases by approx. 25% and the programme takes 5-10 minutes longer to complete. To add the extra rinse:

### The sliding switch

- Pull out my detergent dispenser until the sliding switch in the frame is accessible on the left.
- Set the sliding switch to the right (●●).

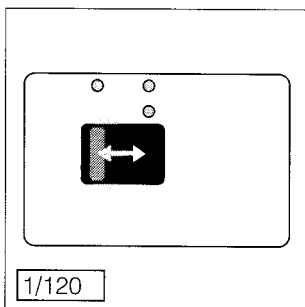

- Re-insert the dispenser.

## Special accessories

Necessary should you wish to remove the existing worktop and install a free-standing automatic washing machine under a continuous worktops.

The kit contains:

- Cover plate with 2 fan discs as contact protection when the worktop is removed

**The automatic washing machine without a worktop should not be used until after installation and earthing of the cover plate as described.**

- 2 sliding rails to assist insertion under worktops
- Foil protection strip for protection of the underside of worktops in the region of the control panel and detergent dispenser.

**Build-under kit  
E-Nr.  
605 898 832**

## Maintenance and care

### Detergent dispenser

From time to time, you should clean my detergent dispenser thoroughly.

- To do this, slightly lift the dispenser and withdraw with a short sharp pull. Detach the syphon in my special conditioner compartment.

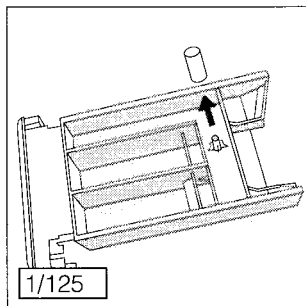

- Clean the dispenser compartments with warm water and a bottle brush.

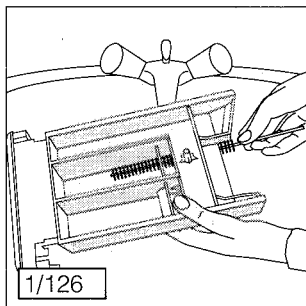

- Clean the syphon under running water. Re-insert the latter fully and check for proper fitting!
- Also clean the roof of the detergent compartments with a brush.
- Re-insert the dispenser in the guides and push it in.
- At the end of the programme, pull the washing powder compartment out a little way so that it dries.

### Laundry drum

My laundry drum is made of stainless steel. Any objects left in the laundry and likely to rust (see the section on "Preparing the laundry") may leave rust stains on the drum. These stains can be removed with a stainless steel cleaner.

Remove any deposits or foreign bodies from the rubber sleeve behind my loading door.

The loading door should not be closed after washing, so that the drum can dry out and the machine is thoroughly ventilated.

If you have ensured correct detergent dosage, your machine will scarcely ever need to be descaled. If descaling should be necessary, use only branded descaling agents with corrosion protection for washing machines. Your service centre stocks suitable agents.

My control panel and controls should be cleaned with luke-warm water only. Do not use furniture polish or abrasive cleaning agents.

**Frost damage does not come under your guarantee!**

If your ÖKO-LAVAMAT is installed in room susceptible to frost, your machine must be subjected to emergency emptying as described in the section on "If you think your washing machine is not working properly..." if there is any imminent risk of frost.

Also unscrew my supply hoses from the water tap and allow the water to run out. Place a cloth underneath!

**Loading door**

**Descaling**

**Control panel**

**Frost protection**

**Minor faults  
you can rectify  
yourself**

## **If you think your washing machine is not working properly ...**

### **... the laundry loading door will not open?**

- Your machine is not connected to the mains supply, or
- You have not pressed the door release button long enough.
- A programme with rinse-hold has been selected.

### **... owing to power failure, the loading door will not open?**

- See "Opening the door in the event of a power failure" at the end of this section.

### **... my washing machine is not working at all?**

- Your machine may not be plugged in (the power plug may not be in the plug socket).
- The ON button has not been pressed.
- The loading door is not properly closed.
- Have you checked the fuses?

### **... no water enters?**

- The water taps may not have been turned on.
- One of the filters in the infill hose is blocked.  
One filter is located in the end of the hoses connected to the water taps: unscrew the infill hoses and clean the filters under running water.

A second filter is located in the connection between hose and machine. Unscrew the infill hose on the machine and clean the filter.

### **... there is a delay before the spin sequence starts?**

- The electronic out of balance monitoring system has responded, owing to poor laundry distribution.  
Your laundry is loosened and distributed by the tumbling action of the drum and the spin sequence restarted. This may happen several times until the imbalance is corrected and the spin sequence can finally start.

### **... my washing machine vibrates?**

- Very small wash loads (e.g. only one bathrobe) may cause your machine to vibrate. This does not affect operation of your machine in any way.

### **... the spin speed fluctuates and is uneven?**

- Owing to excessive sudsing, the Sensortronic electronic foam monitoring system has temporarily reduced the spin speed until the foam is brought under control. Your laundry is respun immediately thereafter.

Check the detergent dosage in the next programme!

### **... the washing machine makes unusual noises?**

- This washing machine possesses a modern drive system, which in comparison with earlier drives produces a different kind of noise, rather like a whistle.

The new drive allows the washing machine to build up speed gently when spin-drying, and to then keep to the speed-level set. The washing machine's stability has thereby been improved and its water-consumption lowered.



**... the machine is oversudsing in the main wash?**

■ You have added too much detergent. Dose the detergent more accurately!

■ Have you used a low lather detergent?

**... my washing machine is noisy?**

■ The drain hose may be kinked, or

■ The drain pump is blocked. In both cases, the water has not been pumped away efficiently or not at all.

See also "Cleaning the drain pump".

■ There may still be transport packing in your washing machine, or your machine has not been properly installed and rocks from side to side.

See the installation instructions!

**... water runs out from under the machine?**

■ The screw coupling on the supply hose or the hose clip in the drain hose may be loose.

■ The drain hose is leaking.

■ The cover of the drain pump in the plinth (fig. 1/31 E) is not properly secured after cleaning or emergency emptying. See "Cleaning the drain pump", in this section.

**... my laundry has not turned out as well as it usually does?**

■ You have added too little detergent.

Underdosage leads to greying of your laundry and to scaling in your machine.

Ensure more accurate dosage!

■ You may not have used the correct detergent.

■ Special heavy soiling has not been pretreated.

■ Have you correctly selected the programme and temperature?

**... the conditioning rinse was not dispensed and the conditioner compartment is filled with water?**

■ The syphon in the compartment is not correctly inserted or is blocked. See "Maintenance and care".

The dispenser was opened while the machine was filling.

■ The washing powder compartment has been pulled out when it should have been dispensing.

**... despite pretreatment, stains are not removed during washing?**

■ The stains may not be washable. Consult specialist (dry cleaners).

**... grey spots ("flecks") are found on the finished laundry (so-called grease balls)?**

■ Laundry soiled by ointments, fats, oils, or body grease, has been washed in too little detergent, therefore the amount of detergent has been insufficient to dissolve the grease. Use more detergent.

■ Your laundry has been washed at too low a temperature.

**... even after the final rinse (rinse-hold), foam is still visible?**

■ Modern detergents cause frothing even in the final rinse water, however, this is not a negative reflection on the rinsing result.

**Minor faults  
you can rectify  
yourself**

**... conditioner flecks remain on the finished laundry?**

- This is in most cases likely to be due to the fact that conditioning rinse – especially in concentrated form – has directly affected your laundry.

Wash out these flecks as quickly as possible, and take care when handling these agents!

**... white detergent residues remain on my laundry after the programme has ended?**

- These residues are insoluble constituents of modern detergents. They are not due e.g. to insufficient rinsing.

Possible remedies: Brush or shake out, and possibly also put laundry back into wash. Check detergent selection.

**... my laundry is insufficiently spun or water remains in the drum?**

- Owing to a kinked hose, the pump is not pumping away sufficient water from your washing machine.
- The pump head of max. 1 m is exceeded. For such cases, the service centre stocks a retrofitting kit with a second pump.
- The drain pump is blocked.

Proceed as follows when cleaning the drain pump:

- **Unplug your washing machine or take out the fuse.**
- Drain the water from the machine as described under “Emergency emptying in the event of a power failure” in the next section.
- Unscrew the drain pump cover anticlockwise (see arrow) and remove together with the insert. Place a cloth underneath as residual water may still run out.

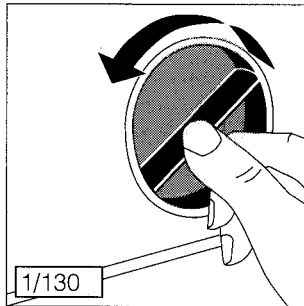

- Remove foreign bodies from the pump housing. Always also check by hand that the pump impeller runs freely.

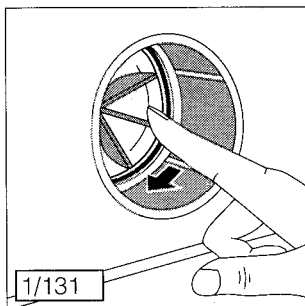

- Replace the cover and close by turning clockwise. Make sure it is closed tightly otherwise water will leak from the pump.
- Close emergency drain hose with plug. Push back into the machine. Secure the plug by rotating it a quarter turn clockwise.

**... the loading door cannot be opened when a power failure has occurred?**

■ Proceed as follows:

- Turn plug A a quarter turn anticlockwise (in the direction of the arrow).

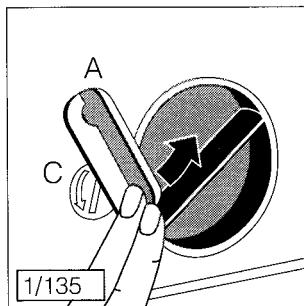

**Minor faults  
you can rectify  
yourself**

- Pull out hose B and remove plug A.

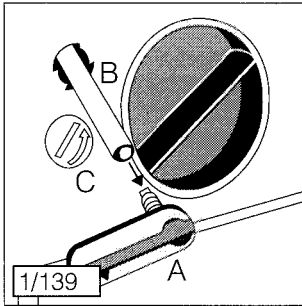

- Allow the residual water to drain into a bowl (place a cloth underneath). Depending on the amount of residual water, it may be necessary, to empty the collecting bowl several times.  
**Take care when the suds are hot!** Where necessary, allow to cool first!
- Replace plug A into the drain.
- To open the loading door, turn knob C anticlockwise (in the direction of the arrow) with a coin or screwdriver until the loading door springs open.
- Push in emergency drain hose and secure A.

**Please note:**

After emergency emptying, your washing machine has been emptied completely.

To ensure the function of my ÖKO lock, it is necessary to add around 1/2 l water to my detergent dispenser.

If, you decide to call the service centre to help with any of the stated instructions or on grounds of faulty operation, the service engineer's visit cannot be made free of charge even during the guarantee period.

## Customer service

If no reference is made to a particular fault in my Operating Instructions, please contact the service centre.

When doing so, quote the product number (E-No.) and serial number (F-No.) of your machine. You will find these numbers on my rating plate.

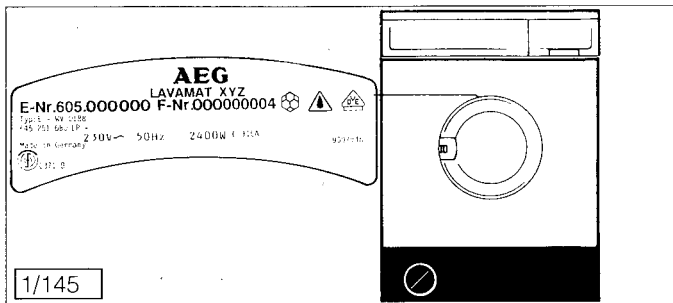

Providing these numbers enables the service centre to make precise identification of the required spare part so that your washing machine can be repaired on the engineer's first visit. You will thus save yourself additional costs due to repeated visits by the service engineer.

To keep these numbers handy, we recommend you to enter them here:

**E-No.** .....

**F-No.** .....

## Technical data

### Dimensions:

With worktop

Height 85.0 cm

Width 60.0 cm

Depth 60.0 cm

Without worktop

Height 82.0 cm

Width 59.5 cm

Depth 57.0 cm

### Connection

Information relating to electrical connection is given on the rating plate and in the separate installation instruction supplied with the machine.

Please ensure that the voltage and current indicated on the rating plate agrees with the voltage of your electricity supply. 220/240 volts – (i.e., 220/240 V AC).

### Drum speeds:

Washing 50 min<sup>-1</sup>

Spinning max. 1400 min<sup>-1</sup>

Optionally 1000/700 min<sup>-1</sup>

### Water pressure:

1-10 bar (= 10-100 N/cm<sup>2</sup> = 0.1-1.0 MPa) cold water supply

0.3-10 bar hot water supply

### Weight empty:

Around 85 kg

This appliance meets the radio/tv suppression requirements of EN 55014/DIN VDE 0875 Part 1, Directives 82/499 EC, 87/308 EC, and EN 55011, DIN VDE 0871 Part 1, as well as the standard for reciprocal effect on electricity mains EN 60 555 Parts 1-3/VDE 0838 Parts 1-3 of June 1987.



AEG Hausgeräte AG  
Postfach 1036  
D-90327 Nürnberg 1

© Copyright by AEG

H 244 262 240 - 06920.5/02

**AEG Domestic Appliances Ltd**

Customer Care Department  
55-77 High Street  
Slough  
Berkshire SL1 1DZ

Telephone: 08705 350350