

# ÖKO\_LAVAMAT 855 U electronic

The Environment-Friendly Washing Machine

Operating Instructions

## Hello

Allow me to introduce myself: I am your AEG ÖKO-LAVAMAT environment-friendly automatic washing machine. From now on, I should like to make washing easier for you, not simply because of my attractive appearance, but also thanks to my "intrinsic qualities". I am economical in terms of energy, water, and detergent consumption, especially quiet in operation, easy to operate, and simple to care for.

**If you carefully read and follow my operating instructions before first use and familiarise yourself with my installation and connection instructions, you are sure to experience a good deal of joy when using me to wash your laundry!**

**You must read these instructions prior to using the appliance and retain them for future reference.**



# Contents

<b>Safety instructions</b>	
Before first use	4
For the user	4/5
You should also note the following	5
<b>The ÖKO system</b>	6
<b>Out of concern for the environment . . .</b>	
ÖKO tips for economical washing	7
The economy programmes	7
<b>Appliance description</b>	
Features	9-11
<b>Brief instructions on machine washing</b>	12
<b>Before starting to wash</b>	
Sorting your laundry	13
Pretreating your laundry	13
Care needed for certain fabrics	14
<b>Loading the laundry</b>	
Recommended wash loads	14
Open loading doors	15
Loading laundry	15
Close loading doors	15
<b>Detergents</b>	
Select detergent	16
Amount of detergent	16
Adding detergent	17
<b>Selecting the wash programme</b>	
Programme selector/programme cycle indicator/ Temperature selector	18/19
The buttons and their functions	20/21
<b>Programme tables</b>	22/23
<b>Consumption values</b>	24
<b>Programme end</b>	25
<b>Cleaning, maintenance, care</b>	25/26
<b>If you think your washing machine is not working properly . . .</b>	27-30
<b>Customer service</b>	31
<b>Technical data</b>	32

# Safety instructions

## Before first use . . .

- Please note my installation and connection instructions.
- Please ensure you have removed all my transport packing. Unless removed, transport packing will cause damage to the appliance and adjacent furniture during spinning.
- You should run an initial wash cycle without laundry to remove residues of factory-applied grease from the drum and tub. Programme: 60 °C cotton programme with half a beaker of detergent.

You may find small water residues in my tub, these are due to the thorough testing which your machine was subjected to in the factory.

## Safety instructions for the user

AEG electrical appliances conform to the recognised safety regulations governing electrical domestic appliances. As manufacturers, we nonetheless feel obliged to familiarise you and any other persons using the machine with the following instructions:

- Please make sure before using your machine for the first time that the mains voltage and supply indicated on my rating plate agree with the mains voltage where the machine is to be used. The fuse required is indicated on the rating plate.
- Before cleaning, care and maintenance work, make sure that the appliance is switched off. We advise for safety reasons that you pull the mains plug out of the socket, switch off at the power point or completely remove the fuse in the fuse box servicing this circuit. (See installation and connection instructions.)
- Never direct a water jet onto my outer casing!
- Never use my supply lead to pull the mains plug out of the socket!
- Never operate me if:
  - my mains supply lead is damaged, or
  - the appliance shows visible damage to the control panel, worktop, or plinth.

If the mains supply lead needs to be changed or damage needs to be repaired, please contact our service centre or AEG authorised service agents.

- **Repairs to electrical appliances should only be performed by a trained electrician. Improper repairs may place the user at serious risk.**

If any other maintenance needs to be carried out, you are recommended to contact our service centre or AEG authorised service agents. Only original AEG spare parts fulfill all requirements!

- If I am installed under a worktop in your kitchen or utility room, i.e. my worktop has been removed, an earthed cover plate must be fitted as access protection according to the installation and connection instructions. (See special accessories.)
- Children may not recognise the dangers of improper use of electrical appliances. Therefore, please ensure proper supervision during use.

- When the day finally comes to withdraw me from service and to replace me with another machine, please make sure that you inactivate my door lock and cut my electrical supply lead, disposing of lead and plug safely. This will prevent children from locking themselves in, thus endangering their lives.
- If I am incorrectly operated or used for any purpose other than that for which I am intended, AEG cannot assume liability for any possible damage.
  
- Please keep my packaging away from children. The foil represents a particular danger. The packaging material meets ecological requirements and can be easily disposed of. You are advised to do this as quickly as possible.
- If the machine is not permanently connected: hook my drain hose securely over the edge of the sink using the hose holder provided. (See section on "Water drainage" in the installation and connection instructions.)
- If your laundry has been pre-cleaned with flammable solvents, these solvents must have fully evaporated before placing the laundry in the machine.
- Never use me for chemical cleaning!
- Dyes/dye removal agents may only be used if the manufacturer of these products expressly allows them to be used in automatic washing machines. Please see their instructions for use. No liability can be assumed for any consequential damage.
- When cleaning my stainless steel drum, never use any iron-containing scouring agents or steel wool! Your service centre has suitable cleaning agents in stock.  
Keep furniture polishes or abrasive cleaners away from my control panel and my controls.  
Only use tap water. Never use any other liquids. You may use rainwater only if it is completely clean, otherwise operation of my electrical solenoid valves could be impaired.

**You should also note the following . . .**

# My ÖKO System

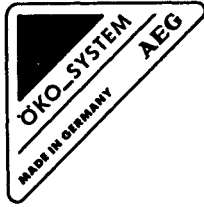

Your new ÖKO-LAVAMAT meets all present and future laundry care requirements and allows individual and versatile programme selection.

It is highly economical in water, energy and detergent consumption, which not only contributes to protection of our environment, but also saves you money.

## **My Special Spin System**

My electronically controlled spin with intermediate spins after the main wash and the 4 rinse sequences on the cotton and linen programmes guarantees very low water consumption:

**For cotton/linens without pre-wash only 88 litres of water**

## **The ÖKO Lock**

My ÖKO lock ensures 100% effective detergent utilisation. The ÖKO valve closes off the wash tub from the drainage system during all wash programmes. This not only reinforces the cleaning effect but also saves detergent – a saving of 20% in comparison with machines without such a device.

## **The Stream Clean**

The special AEG wash paddles carefully scoop up the wash solution, and on reaching the top of the drum, gently spray streams of water through your wash load. This system ensures that your laundry is at all times soaked in the wash solution.

## **The Automatic Flowrate Feature**

My automatic flowrate feature automatically adjusts the water consumption to the wash load and fabric type concerned. By additionally pressing the ½ load button for small wash loads, you can save even more water.

## **The Short Programmes**

For lightly soiled and small wash loads, eg in the case of sports and leisure clothing, use the short programmes.

## **The Wool Cradle**



My wool cradle takes special care of your woollens: with a very gentle washing action, these especially sensitive garments are gently "rocked" to and fro in the drum.

## Out of concern for the environment . . .

These hints are intended to help you act in an environmentally conscious manner.

- For normally soiled laundry, the programmes are intended for use without prewash. Compared to a programme with prewash, you save detergent and water.
- It is more economical to wash full loads. If you find it necessary to wash small loads, you should use my  button. Add only  $\frac{2}{3}$  to  $\frac{1}{2}$  of the amount of detergent for a full load. This will result in consumption of less water, energy and detergent.
- For light to normally soiled laundry, it is often sufficient to use my economy programme, ie at a lower temperature for a longer time.
- With suitable pretreatment, stains and limited soiling can be removed. This saves a programme being used for heavily soiled laundry.
- Dose your detergent exactly as instructed by the detergent manufacturer, bearing in mind that because of the ÖKO lock you can use 20% less. Overdosage wastes money and burdens the environment. You should also note the instructions for lightly soiled laundry.
- Detergent savings and care for the environment can also be achieved by dosing the detergent as for soft water although you have medium to high water hardnesses, and additionally adding a water softener. This reduces the amount of "chemicals" entering our water ways.
- Use fabric softeners only where necessary, eg for synthetic or mixed fabrics, to avoid static. If you use a tumble dryer, your laundry will be soft and fluffy without a fabric softener.

### Here are my economy programmes:

-  – Programmes for half and small wash loads
-  – Programmes for fabrics where soiling does not require the full programme at a high temperature

## ÖKO Tips for Economical Washing

## Economy Programmes





## Appliance description

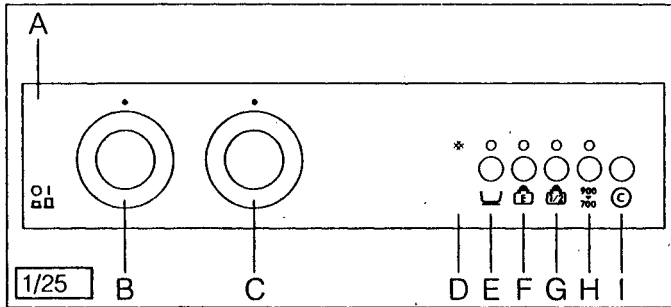

- A** Control panel
- B** 6-setting programme selector with programme cycle indicator
- C** Temperature selector
- D** Pilot lamp
- E** Easy-care fabrics/woollens button
- F** Energy-saving or intensive washing button
- G** Small wash load button
- H** Spin speed selector button
- I** Cancel button

## Features

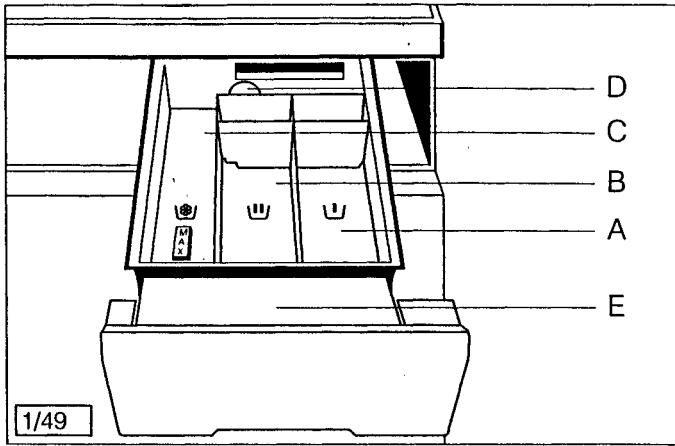
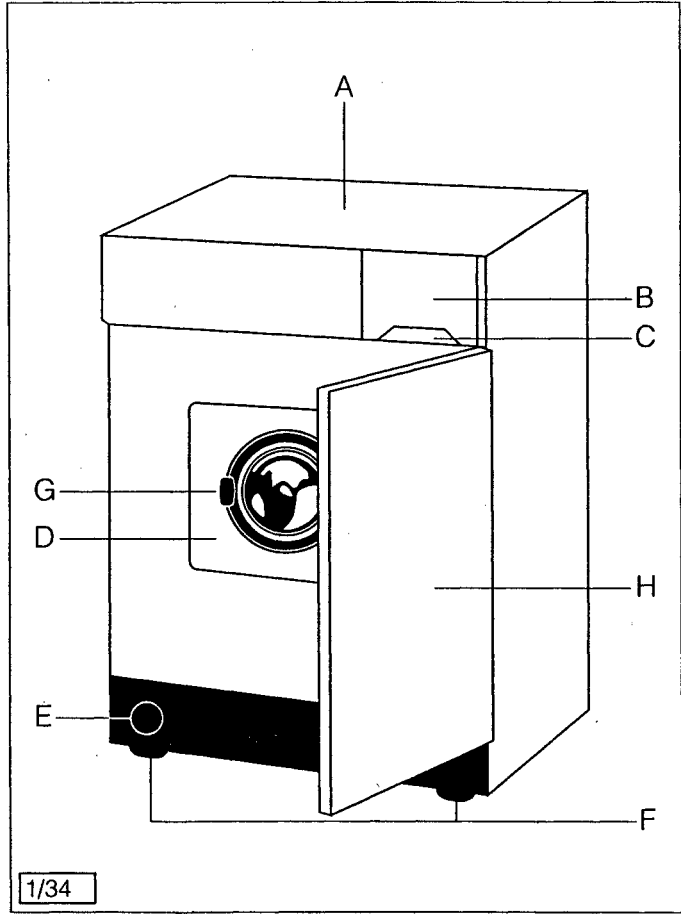

- A** Cover plate
- B** Dispenser with compartments for detergent and fabric conditioner and with removable programme card printed on both sides
- C** Detergent dispenser handle
- D** Laundry loading door, opened via door release handle
- E** Drain pump (cover with debris trap opens for cleaning) – on LH side of pump cover, emergency drain hose
- F** 4 height-adjustable screw-in feet (front and rear)
- G** Door handle
- H** Outer door



- 
- A** Prewash detergent compartment
  - B** Detergent compartment for main wash
  - C** Liquid conditioner compartment (fabric softener, liquid conditioner, starch)
  - D** Siphon (must be securely inserted)
  - E** Programme card\*)

\*) You can re-order my programme card from your service centre if it ever gets lost.

## Features

**The dispenser for detergent and fabric conditioner**

## Brief instructions on machine washing

<b>Preparing the laundry</b>	Sorting Pretreatment Care needed for certain fabrics
<b>Loading the laundry</b>	Open outer and loading doors Distribute laundry in the drum Close doors
<b>Detergent dosage</b>	Select detergent Measure amount of detergent Add detergent/fabric conditioner Close dispenser
<b>Selecting the wash programme</b>	Set programme selector Set temperature selector Press option buttons (see programme table or programme card in dispenser) Pull out programme selector switch. The programme starts. The pilot lamp lights up as soon as the loading door is locked.
<b>Continuing the programme</b>	On programmes with rinse-hold  , to drain the water from laundry: Set programme selector to 9 or 10 – see programme tables.
<b>When the programme has finished</b>	The programme has ended when the pilot lamp goes out. Push in programme selector Release depressed buttons with cancel button  . Open outer and loading doors. Take out the laundry. If no more laundry is to be washed: Turn the programme and temperature selectors to the OFF position.

## Before starting to wash

- Check that the fabrics are machine-washable. The international care labels will give you guidance.
- Woollens labelled only with the woolmark  are **not** suitable for machine-washing. Also garments marked with the following symbols:

**Hand wash**



**Do not wash**



- Sort your laundry into laundry types as follows, separating coloureds from whites:

**Cotton/linen – Whites**



**Cotton/linen – Coloureds**

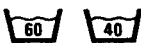

**Easy-care fabrics**



**Delicates**



**Woollens**



- Woollens must be labelled with the woolmark and additionally marked "will not felt", "non-felting", or "machine-washable".
- Coloureds and whites should never be washed together, whites will turn grey.  
New dark coloured laundry will often state "wash separately". This type of garment will often have surplus colour which may be transferred to lighter fabrics during washing. Always wash such items on their own for the first few washes.
- Wherever possible remove **stains** immediately, before they have set. You are recommended to try water and soap first, possibly treating heavy stains with a special pretreatment agent or liquid detergent. Do not rub, only work in.

## Sorting your laundry

## Pretreating your laundry

## Care needed for Certain Fabrics

### ■ Empty pockets

Please make sure that no metal objects (eg paper clips, staples, coins, safety pins, or the like) remain in the laundry.

Button up pillow cases, close zip-fasteners, hooks and eyes. Tie together loose belts and long apron strings.

Turn knitted garments (knitwear) inside out.

### ■ Particularly small or sensitive garments (eg baby socks, ladies tights, etc) should be washed in a launder net bag or pillowcase.

### ■ Handle curtains especially carefully

Remove rings and hooks from your curtains, to avoid damage or tearing. Synthetic curtains should be handled carefully as they snag easily. Place net curtains in a pillowcase or wash bag.

Under no circumstances can we accept liability for damage to curtains through incorrect handling.

Spin curtains only when permitted by the manufacturer.

## Loading your laundry

### Wash loads (maximum dry loads)

	Full load	With button  for small loads
Cotton/linen – Whites/coloureds normally soiled	5.0 kg	2.5 kg
heavily soiled	3.5 kg	1.8 kg
Easy-care fabrics and delicates	2.0 kg	1.0 kg
Woolens	1.0 kg	–
Short programme for whites/coloureds	2.5 kg	1.3 kg
Short programme for easy-care fabrics	2.0 kg	1.0 kg

Use the recommended full load wherever possible, as this is the most economical way to wash.

Do not overload!

This will adversely affect the wash result and can result in permanent creasing.

Press the outer door on the top LH corner (on the top RH corner when the door is hinged at the left). The door springs open.

Slide the sliding switch on the door handle to the right (towards the door glass centre) and then pull the door handle forward.

- when the programme has ended, as soon as the pilot lamp has gone out.
- during the programme when my programme selector switch is pushed in and the locking time of 1-2 minutes has elapsed. When opening the door, **note the water level in the drum.**

Loosely load your unfolded laundry in to the drum, mixing small and large items as much as possible. This reinforces the washing action and promotes even distribution of the laundry during spinning.

Press the door closed so that the catch clicks into position.

For your safety, my loading door is locked throughout the programme cycle. So long as my pilot lamp is on when the machine is connected, the loading door cannot be opened.

**Opening and closing the loading door**  
**To open the outer door:**

**To open the loading door**

**The loading door can be opened**

**Loading**

**To close:**

**Safety lock**

## Detergents

### Selecting your detergent

Use only detergents that are suitable for automatic washing machines.

You will achieve the best cleaning results with minimum harm to the environment by also considering the type of laundry soiling when selecting a suitable detergent.

Machine-washable soiling is basically classified as:

- **Dirt**, e. g. dust, soot, sweat, grease, etc.
- **Stains**, e. g. tea, red wine, fruit, blood

### Detergents

You will find BIO and NONBIOLOGICAL detergents in powder or liquid forms. Check with the detergent manufacturers information as to which detergent suits your purposes best bearing in mind that the detergent must be a low lather one suitable for automatic washing machines! **We recommend ARIEL (in the various different forms) and Dreft automatic for woollens.**

### Washing aids

- **Water softeners** allow the use of smaller amounts of detergents in households having medium-hard to very hard tap water.
- **Fabric softeners** prevent the static charging of synthetic fabrics and make your laundry soft to the touch. If you use a tumble dryer, your laundry will be soft and fluffy without a fabric conditioner. We recommend LENOR fabric conditioner.
- **Starches, conditioning rinses**, ensure that your laundry keeps its shape.

### Amount of detergent

The amount of detergent used depends on the hardness range of your tap water. With an increasing water hardness, more detergent must be dosed to bind the lime contained in the water. You will find dosage indications for soft or hard water on the detergent pack.

For lightly soiled laundry, use less detergent. Follow the detergent manufacturers instructions. If the latter gives no dosage indications for small loads, you should reduce by  $\frac{1}{3}$  for half wash loads and for even smaller loads use  $\frac{1}{2}$  the amount recommended for a full load. You can save detergent and prevent unnecessary amounts of detergent from entering our waterways by using a special water softener in areas with hard water.

You should dose the special softener depending on the water hardness as instructed on the softener package. In this case, you should **always dose the detergent for "soft" water** as instructed on the detergent packages.

In this case, add the detergent and softener **together** in the main wash compartment. When using programmes with prewash, add it to the respective compartments for prewash and main wash.



The detergent dispenser has three compartments:

Compartment (right)  = washing powder for programmes **with prewash**

Compartment (centre)  = washing powder for main wash

Compartment (left)  = liquid conditioner (conditioning rinse, starch)

**Please also note the following:**

- When adding detergent and water softener, fill **first detergent and then softener** in the same compartments.
- If you prefer **liquid detergents**, dose these agents as instructed by the detergent manufacturer, using the “balls” supplied or offered by the detergent manufacturer.
- When using liquid, follow the manufacturers’s instructions.
  
- **Do not fill above “MAX”** indicator level as otherwise the liquid may drain immediately.
- **When using thick concentrated fabric conditioner and starches**, you are recommended to mix the concentrate with water to ensure troublefree dispensing.
- If you want to use **starch powder**, dissolve according to the manufacturers’s instructions and place in compartment , selecting the “Fabric conditioning – Conditioning rinse – Starching” programme.

**Dosing the detergent**

**Dosing powders**

**Dosing liquids**

**Dosing fabric conditioners**

## Selecting the wash programme

Select my wash programmes with the programme selector (fig. 1/25 B), temperature selector (fig. 1/25 C), and buttons (fig. 1/25 E to I).

For normally soiled laundry, select a programme without prewash.

For heavier soiling, select programme  with prewash or for delicates, programme 6.

For fabrics where soiling is of a protein nature (e.g. blood, milk), select a programme with prewash to prevent these stains from setting.

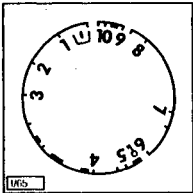

### The programme selector



My programme selector has 11 settings for the main and additional programmes. The programme with prewash is marked by the symbol  for cotton/linens and easy-care laundry, the other programmes by the numbers 1-10. (See programme table.)

### Energy-saving or intensive wash

In position "1", the length of time taken for the main wash is prolonged.

■ **When washing light to normally soiled laundry, you can save up to 40% energy** by using a lower temperature (using button  and  instead of ).

■ **When washing heavily soiled laundry (without button )**, you achieve a more intensive washing effect.

The programme selector must only be turned **clockwise** and only **when the machine is switched off**.

### Switching on and off



The programme selector is also used to switch your machine on and off.

To switch on: Pull out the programme selector

To switch off: Push in the programme selector



You will also find the symbols opposite on the control panel.

My temperature selector is continuously variable to all necessary temperatures. On setting 0, you can wash in cold water, e. g. woollens.

If you wash at high temperatures, the loading door window gets hot. Do not touch it!

### The temperature selector

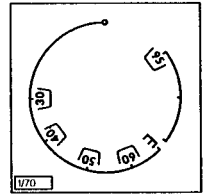

During the programme, the programme cycle indicator rotates step by step below the window indicating which part of the programme has been reached.

At certain stages in the programme – the programme cycle indicator will remain stationary for some time. This is particularly noticeable on the “woollens” programme.

### The programme cycle indicator

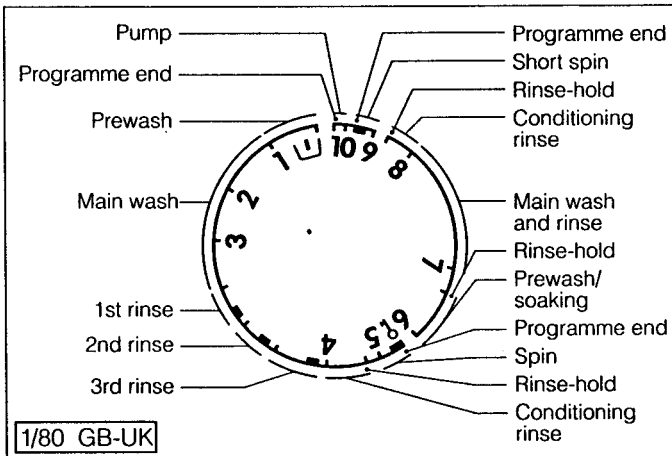

- – 5 Cotton/linens/easy-care fabrics
- 6 – 8 Delicates/woollens

## The button functions

By combining the main and additional programmes with my buttons, you will have a range of programmes meeting all your laundry requirements.

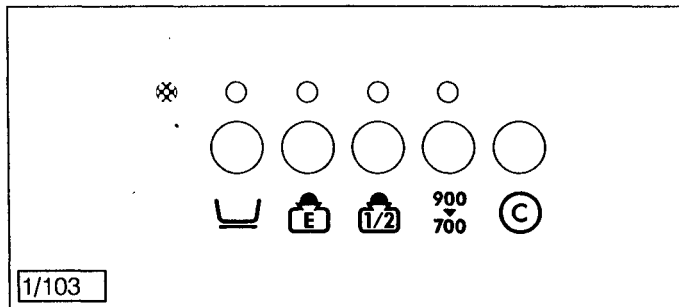

When the buttons are pressed, a red indicator appears in the display above.

### Easy-care laundry Woollens Soaking



Effect:

#### ■ For easy-care laundry

No intermediate spin after rinse cycles. The laundry is retained in the last rinse water.

#### ■ For woollens

Very gentle drum action. No intermediate spin after rinse cycles. The laundry is retained in the last rinse water.

#### ■ During soaking (programme 6)

Your laundry can be soaked for any length of time.

### Energy-saving



Effect:

The temperature in the main wash is reduced to around 67 °C.

By combining this button with number 1 on the programme selector (the length of the wash time is increased), you can save up to 40% energy.

### Small wash loads



Effect:

#### ■ For cotton/linens and easy-care laundry

Reduced water level during rinsing (water saving).

#### ■ For delicates

Reduced water level during washing and rinsing (water and energy saving).

This button has no effect for woollens.

It makes sense to press both  and  buttons together when you want to wash small loads saving energy.

Using this button, you can determine the spin speed and decide how your laundry should be spun.

If you do not press this button, your laundry is automatically spun at the maximum speed.

**Select maximum speed if this sequence is to be followed by drying in a tumble dryer as both time and energy will be saved.**

**Easy-care fabrics** are spun in a three-stage Variomatic spin programme. The laundry is repeatedly loosened.

For **easy-care fabrics and delicates**, the spin speed is **limited to max. 850 rpm**. It can be reduced to 700 rpm.

**Delicates and woollens** are automatically subjected to a **short spin sequence**.

Effect:

Depressed programme buttons are released.

### Energy-saving washing of small wash loads



### Selecting the spin speed

900













▼  
700



























### Releasing the buttons



## Programme table

Care label Laundry	Pro- gramme	Wash load	Programme setting Pro- gramme selector	Tempera- ture selector	But- tons
 Cotton/linen	Whites/ coloureds	up to 5 kg <sup>1)</sup>	2 <sup>2)</sup>	cold to <u>95</u>	
 Cotton/linen	Energy- saving prog- ramme <b>E</b>	up to 5 kg <sup>1)</sup>	1 <sup>2)</sup>	<u>95</u>	
 Cotton with special finishes mixed cotton fabrics, i.e. polyester/ cotton, synthetics	Easy-care	up to 2 kg	2 <sup>2)</sup>	up to <u>50</u>	
 Synthetics/curtains	Delicates	up to 2 kg	7 <sup>2)</sup>	up to <u>40</u>	
 Woollens/ mixed woollens	Woollens 	up to 1 kg	7	up to <u>40</u>	
 Cotton/linen	Short wash	up to 2.5 kg	3	up to <u>40</u>	
 Easy-care/delicates	Short wash	up to 2 kg	3	up to <u>40</u>	
Cotton/linen	Condition- ing-rinse, starching	up to 5 kg	4	-	
Easy-care/delicates		up to 2 kg	8	-	
Cotton/linen	Spin	up to 5 kg	5	-	
Easy-care/delicates Woollens		up to 2 kg	9	-	
	Extra prewash - soak	up to 3.5 kg	6	up to <u>40</u>	
	Pumping out		10	-	

Programme cycle	Possible additional buttons	Instructions
Main wash – intermediate spin – 4 rinses with intermediate spinning – final spin	 900  700	The steps you must take before each programme are given in the "Brief instructions".  1) 3.5 kg for heavily soiled laundry 2) With prewash  on delicates programme 6  = Rinse-hold
	 900  700	
Main wash – 4 rinses – rinse-hold	 900  700	The laundry remains in the last rinse water or in the soaking solution.  You must pump out or spin your laundry.
Main wash at high water level, reduced drum action – 4 rinses – rinse-hold	 900  700	
Main wash at high water level, gentle drum action – 3 rinses – rinse-hold	 900  700	
Short main wash – 4 rinses – rinse-hold	 900  700	
Short main wash – 4 rinses – rinse-hold	 900  700	
Rinsing – pumping out – final spin	 900  700	
Rinsing – rinse-hold	 700	
Pumping out – final spin	 900  700	
Pumping out – short spin	 900  700	
Extra prewash (or soak programme at high water level  ) The laundry can remain in the detergent solution for any length of time		
Pumping out, e.g. after rinse-hold		

**Consumption Values**  
**Energy, water and time for programmes**  
**listed below (cold water connection)**

Programme	Water (litres)	Energy (kWh)	Time (minutes)
Cotton/linen 95 °C, full load	88	2.1	130
Cotton/linen 95 °C with half load button, half load	54	1.6	115
Energy saving programme, full load	88	1.5	150
Cotton/linen 60 °C, full load	88	1.1	100
Cotton/linen 40 °C, short, half load	80	0.4	55
Easy-care fabrics 50 °C, 2 kg load	76	0.7	70
Easy-care fabrics 30 °C, with half load button, short, 1 kg load	44	0.2	55
Delicates 40 °C, 2 kg	64	0.7	70
Wool 40 °C, 1 kg load	66	0.6	70

The above values were established with standard test loads. These values can vary up or down with normal household loads. The energy consumption will be lower on a hot and cold fill connection. Programmes with prewash (except for wool) will take approximately 20 minutes longer.



## Programme end

As soon as my pilot lamp goes out, the loading door can be opened. Release any depressed buttons with release button C. Push in the programme selector switch. Your washing machine is switched off. Turn the temperature selector to the  $\circ$  position.

Take out the laundry.

Check that my drum is completely empty, otherwise fabrics may be damaged during the next wash (e.g. shrink) or discolour other laundry.

## Maintenance and care

From time to time, you should clean my detergent dispenser thoroughly.

- To do this, slightly lift the dispenser and withdraw with a short sharp pull. Detach the syphon in my special conditioner compartment.

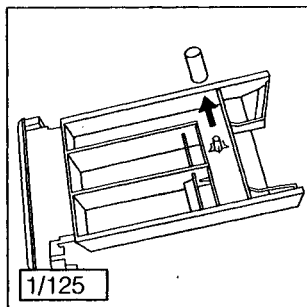

- Clean my dispenser compartments with warm water and a bottle brush.

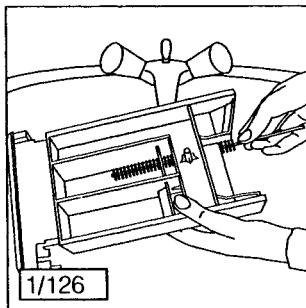

- Clean the syphon under running water. Re-insert the latter fully and check for proper fitting!
- Also clean the roof of the detergent compartments with a brush.
- Re-insert the dispenser in the guides and push it in.

**Open the door –  
Switch off  
your machine**

**Detergent  
dispenser**

<b>Laundry drum</b>	My laundry drum is made of stainless steel. Any objects left in the laundry and likely to rust (see the section on "Preparing the laundry") may leave rust stains on the drum. These stains can be removed with a stainless steel cleaner.
<b>Loading door</b>	Remove any deposits or foreign bodies from the rubber gasket behind my loading door. The loading door should not be closed after washing, so that the drum can dry out and the machine is thoroughly ventilated.
<b>Descaling</b>	If you have ensured correct detergent dosage, your machine will scarcely ever need to be descaled. If descaling should be necessary, use only branded descaling agents with corrosion protection for washing machines. Your service centre stocks suitable agents.
<b>Control panel</b>	My control panel and controls should be cleaned with luke-warm water only. Do not use furniture polish or abrasive cleaning agents.
<b>Frost protection</b>	<p><b>Frost damage does not come under your guarantee!</b></p> <p>If your ÖKO-LAVAMAT is installed in room susceptible to frost, your machine must be subjected to emergency emptying as described in the section on "If you think your washing machine is not working properly..." if there is any impending risk of frost.</p> <p>Also unscrew my supply hoses from the water tap and allow the water to run out. Place a cloth underneath!</p>

## **If you think your washing machine is not working properly ...**

### **... the laundry loading door will not open immediately when the programme is interrupted?**

- The door will open after 1-2 minutes (safety lock).
- A programme with rinse-hold has been selected.

### **... my washing machine is not working at all?**

- Your machine may not be plugged in (the power plug may not be in the plug socket).
- The programme selector switch has not been pulled out.
- The loading door is not properly closed.
- Have you checked the fuses?

### **... no water enters?**

- The water taps may not have been turned on.
- One of the filters in the water supply hoses is blocked.  
One filter is located in the end of the hoses connected to the water taps: unscrew the infill hoses and clean the filters under running water.  
A second filter is located in the connection between hose and machine. Unscrew the infill hose on the machine and clean the filter.

### **... there is a delay before the spin sequence starts?**

- The electronic out of balance monitoring system of your machine has responded, owing to poor laundry distribution.  
Your laundry is loosened and distributed by the tumbling action of the drum and the spin sequence restarted. This may happen several times until the imbalance is corrected and the spin sequence can finally start.

### **... my washing machine vibrates?**

- Very small wash loads (e.g. only one bathrobe) may cause your machine to vibrate. This does not affect operation of your machine in any way.

### **... the machine is oversudsing in the main wash?**

- You have added too much detergent. Dose the detergent more accurately!
- Have you used a low lather detergent?

### **... my washing machine is noisy?**

- The drain hose may be kinked, or
- The drain pump is blocked. In both cases, the water has not been pumped away efficiently or not at all.  
See also "Cleaning the drain pump".
- There may still be transport packing in your washing machine, or your machine has not been properly installed and rocks from side to side.  
See the installation instructions!

**Minor faults  
you can rectify  
yourself**

**Minor faults  
you can rectify  
yourself**

**... water runs out from under the machine?**

- The screw coupling on the supply hose or the hose clip in the drain hose may be loose.
- The drain hose is leaking.
- The cover of the drain pump in the plinth (fig. 1/34 E) is not properly secured after cleaning or emergency emptying. See "Cleaning the drain pump", in this section.

**... my laundry has not turned out as well as it usually does?**

- You have added too much or too little detergent.  
Underdosage leads to greying of your laundry and to scaling in your machine. Overdosage leads to frothing, reduced wash performance, and also to poor rinsing results.
- You may not have used the correct detergent.
- Special heavy soiling has not been pretreated.
- Have you correctly selected the programme and temperature?

**... the conditioning rinse was not dispensed and the conditioner compartment is filled with water?**

- The syphon in the compartment is not correctly inserted or is blocked. See "Maintenance and care".

**... despite pretreatment, stains are not removed during washing?**

- The stains may possibly not be washable. Consult specialist (dry cleaners).

**... grey spots ("flecks") are found on the finished laundry (so-called grease balls)?**

- Laundry soiled by ointments, fats, oils, or body grease, has been washed in too little detergent, therefore the amount of detergent has been insufficient to dissolve the grease. Use more detergent.
- Your laundry has been washed at too low a temperature.

**... even after the final rinse (rinse-hold), foam is still visible?**

- Modern detergents cause frothing even in the final rinse water, however, this is not a negative reflection on the rinsing result.

**... conditioner flecks remain on the finished laundry?**

- This is in most cases likely to be due to the fact that conditioning rinse – especially in concentrated form – has directly affected your laundry.  
Wash out these flecks as quickly as possible, and take care when handling these agents!

**... white detergent residues remain on my laundry after the programme has ended?**

- These residues are insoluble constituents of modern, phosphate-free detergents. They are not due to insufficient rinsing. Possible remedies: Brush or shake out, or wash your laundry turned inside out. Check detergent selection.

**... my laundry is insufficiently spun or water remains in the drum?**

- Owing to a kinked hose, the pump is not pumping away sufficient water from your machine.
- The pump head of max. 1 m is exceeded. For such cases, the service centre stocks a retrofitting kit with a second pump.
- The drain pump is blocked.

Proceed as follows when cleaning the drain pump:

- **Unplug your washing machine or take out the fuse.**
- Drain the water from the machine as described under "Emergency emptying in the event of a power failure" in the next section.
- Unscrew the drain pump cover anticlockwise (see arrow) and remove together with the insert. Place a cloth underneath as residual water may still run out.

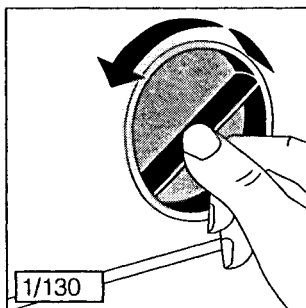

- Remove foreign bodies from the pump housing. Always also check by hand that the pump impeller runs freely.

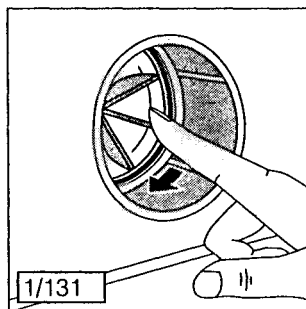

- Replace the cover and close by turning clockwise. Make sure it is closed tightly otherwise water will leak from the pump.
- Close emergency drain hose with plug. Push back into the machine. Secure the plug by rotating it a quarter turn clockwise.

**Minor faults  
you can rectify  
yourself**

... the washing machine no longer pumps water away and a high water level can be seen in the window?

■ Proceed as follows:

- Turn plug A a quarter turn anticlockwise (in the direction of the arrow).

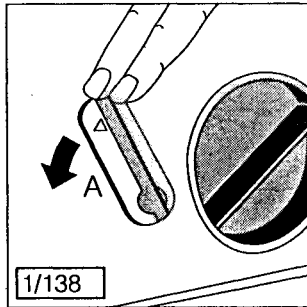

- Pull out hose B and remove plug A.

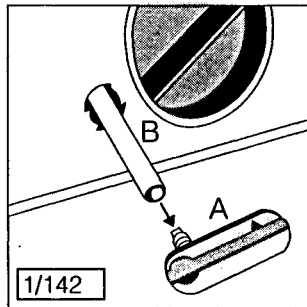

- Allow the residual water to drain into a bowl (place a cloth underneath). Depending on the amount of residual water, it may be necessary, to empty the collecting bowl several times.  
**Take care when the suds are hot!** Where necessary, allow to cool first!
- Replace plug A into the drain hose B.
- Push in emergency drain hose and secure A.

**Please note:**

After emergency emptying, your washing machine has been emptied completely.

To ensure the function of my ÖKO lock, it is necessary to add around 1/2 l water to my detergent dispenser.

If, you decide to call the service centre to help with any of the stated instructions or on grounds of faulty operation, the service engineer's visit cannot be made free of charge even during the guarantee period.

## Customer service

If no reference is made to a particular fault in my Operating Instructions, please contact the service centre.

When doing so, quote the product number (E-No.) and serial number (F-No.) of your machine. You will find these numbers on my rating plate.

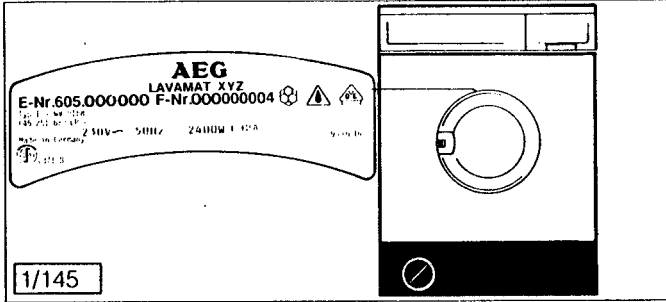

Providing these numbers enables the service centre to make precise identification of the required spare part so that your washing machine can be repaired on the engineer's first visit. You will thus save yourself additional costs due to repeated visits by the service engineer.

To keep these numbers handy, we recommend you to enter them here:

**E-No.** .....

**F-No.** .....

## Technical data

### Dimensions:

Height 82.0 cm  
Width 59.9 cm  
Depth 57.0 cm

### Connection

Information relating to electrical connection is given on the rating plate and in the separate installation instruction supplied with the machine.

Please ensure that the voltage and current indicated on the rating plate agrees with the voltage of your electricity supply. 220/240 volts – (i.e., 220/240 V AC).

### Drum speeds:

Washing 50 min<sup>-1</sup>  
Spinning max. 850 min<sup>-1</sup>  
Optionally 700 min<sup>-1</sup>

### Water pressure:

1-10 bar (= 10-100 N/cm<sup>2</sup> = 0.1-1.0 MPa) cold water supply.  
0.3-10 bar hot water supply

### Weight empty:

Around 80 kg

The appliance is radio-interference suppressed in accordance with EC Directive 82/499/EC, EN 55014/DIN VDE 0875 Part 1, Dec. 1988, as well as with the Standard relating to the Retroactive Effect of the Mains Supply EN 60555 Parts 1-3/DIN VDE 0838 Parts 1-3, June 1987.

AEG Hausgeräte AG  
Postfach 1036  
D-90327 Nürnberg 1

© Copyright by AEG

H 244 268 840 - 04910.5/02 -

**AEG Domestic Appliances Ltd**

Customer Care Department

PO Box 47, Newbury

Berkshire, RG14 5XL

Telephone: 01635 572700

Fax: 01635 42970