

# LAVATHERM 3400 microcomputer

Tumble Dryer

Operating Instructions

# Hello

Allow me to introduce myself: I am the tumble dryer LAVATHERM from AEG. From now on, I should like to make tumble drying more fun for you, not only because of my attractive appearance, but also thanks to my »intrinsic qualities«. I use very little energy, take great care of your laundry and I am very quiet in operation, easy to use and look after.

**You must read these instructions prior to using the appliance and retain them for future reference.**



# Contents

<b>Safety instructions</b>	
Before first use	4
For the user	4/5
You should also note the following	5/6
<b>Out of concern for the environment...</b>	7
<b>Important recommendations for drying</b>	8/9
<b>Appliance description</b>	10/11
<b>Before starting to dry</b>	12
<b>How to tumble dry correctly</b>	12
<b>Loading the laundry</b>	
Open loading door	13
Loading laundry	13
Adding or removing laundry	13
<b>Selecting the drying programme</b>	
Programme selector	14
LED indicators for degree of dryness and programme end	14/15
The push buttons and their functions	15/16
<b>Programme charts</b>	18/19
<b>Cooling phase and automatic anti-crease programme</b>	20
<b>Programme end</b>	
Switching off the appliance	20
<b>Indicating operating errors</b>	21
<b>Cleaning the fluff filter</b>	22
<b>Cleaning, care and maintenance</b>	22
<b>If you think your machine is not operating properly</b>	23
<b>Optional extras</b>	23
<b>Service</b>	24
<b>Technical Data</b>	25

# Safety instructions

## Before first use

- It must stand on a firm and level base. My 4 adjustable feet allow for small height adjustments to compensate for uneven floor conditions. To adjust my feet insert a screwdriver into the vertical slots visible at the front.
- Wipe my drum with a damp cloth.
- I must not be sited in areas which may be affected by frost as the reliability of the electronic components will be adversely affected by sub-zero temperatures.
- The door can be hinged on the left or the right. Re-hinging of the door has to be carried out by an AEG Service Engineer or by an AEG appointed Service Agent.
- If you have to site me next to a gas, coal or electric cooker due to space problems, you have to place a heat insulating board (dimensions 85 x 57.5 cm) between me and the cooker. The side facing the cooker should be covered with aluminium foil.

## Safety instructions for the user

AEG electrical appliance conform to the recognised safety regulations governing electrical domestic appliances. As a manufacturer, we nonetheless feel obliged to familiarise you and any other persons using the machine with the following instructions:

- To ensure safe operation I must only be operated according to the operating instructions.
- Please make sure before using your machine for the first time that the mains voltage and supply indicated on my rating plate agrees with the mains voltage where the machine is to be used. The fuse required is indicated on the rating plate.
- I am a domestic tumble dryer suitable for drying the usual household laundry. Check with the care labels in the laundry whether the manufacturer of the garment recommends tumble drying.
- Only dry laundry which has been washed in water and has been spin-dried.
- Before cleaning, care and maintenance work, make sure that the appliance is switched off. We advise for safety reasons that you pull the mains plug out of the socket, switch off at the power point or completely remove the fuse in the fuse box serving this circuit.
- Keep my surrounding area free from fluff.
- Never direct a water jet onto my outer casing!
- Never use my supply lead to pull the mains plug out of the socket!
- Never operate me if:
  - My mains supply lead is damaged, or
  - I show visible damage to the control panel, worktop or plinth.If the mains supply lead needs to be changed or damage needs to be repaired, please contact AEG service centre or AEG authorised service agents.
- **Repairs to electrical appliances must only be carried out by trained electricians. Improper repairs may place the user at serious risk.**

- We recommend that repairs to AEG appliances should only be carried out by AEG service engineers or by AEG appointed service agents. This way you ensure that AEG spare parts are used which fulfil all the necessary requirements.
- If I am installed under a worktop in your kitchen or utility room, ie. my worktop has been removed, an earthed cover plate must be fitted as access protection according to the Build-under installation instructions.
- Do not lean or sit on the open loading door – risk of machine tipping over.
- Children cannot recognise dangers when tampering with electrical appliances. Therefore, ensure proper supervision when appliances are in use.
- After drying has been completed, always close the loading door to prevent children or pets climbing into the drum.
- My exhaust air must not be vented into a chimney flue.  
My exhaust air must not be ducted into shafts which serve as ventilation shafts of heated areas.  
Avoid sitting me in areas where coal, oil or gas burning stoves are discharging into a chimney flue and where the depression is 0.04 mbar and more.  
Ensure sufficient ventilation of the installation area to prevent depression.
- When the day finally comes to withdraw me from service and to replace me with another machine, please make sure that you deactivate my door lock and cut off my electrical supply lead, disposing of lead and plug safely. This will prevent children from locking themselves in and endangering their lives. Then ensure environment-friendly disposal.
- If I am incorrectly operated or used for any purpose other than that for which I am intended, AEG cannot assume liability for any possible damage.
- Do not use me to stand on.
- During drying my rear panel will get hot. This is normal. Take care and do not touch.
  
- Please keep my packaging away from children. The foil represents a particular danger. Dispose of this material as quickly as possible. You will find details of the type of packaging materials used and how to dispose of these correctly in the literature accompanying the machine.
- Only dry in the tumble dryer articles which have been washed in water. **Do not** dry articles which have been cleaned in inflammable liquids, e.g. dry cleaning fluids or stain removers (benzine, alcohol etc.).
- Do not dry articles containing foam rubber or rubber-like materials in the tumble dryer (risk of fire).

**You should also  
note the  
following**

- Garments which contain residue of hairspray, nail varnish remover, hair styling agents. etc. must not be dried in the tumble dryer
  - risk of gas formation.
- Fabric conditioner sheets leave some residue on the fluff filter of the machine and they may actually block the filter. We would recommend that you use liquid fabric conditioner as part of the wash cycle rather than the conditioner sheets, if you want to use conditioner at all.
- Laundry which is dried in a tumble dryer is fluffy and soft and for environmental reasons you may decide not to use fabric conditioner.
- If you are using perfume-free or ecologically sound washing agents without perfume you may find that your laundry is not smelling as fresh as it used to. These are textile odours which have not been neutralised or covered by the perfumes normally found in washing detergents.
- Make sure that no garments are trapped in my loading door, otherwise damage will occur to the article.
- I can only start to work when my door is closed. When the door is open a safety switch prevents me from operating.
- If you are surprised by the amount of fluff in my filter after the drying cycle let me assure you that I **do not** subject your laundry to a lot of wear and tear. Fluff collected in my filter is due to you using and wearing your laundry and some due to washing in a washing machine. I only create 0.03 g of fluff per 1 kg of laundry.
- Do not use descalers containing acid, chlorine or ferrous substances or even soap filled pads to clean my stainless steel drum. AEG Service stocks appropriate cleaners for this purpose.
- Do not use furniture polish or abrasive cleaning agents on my control panel and controls. Wipe with soft cloth and lukewarm water only.

## Out of concern for the environment

All tumble dryers require energy to dry. I operate very economically if you bear the following information in mind:

### ■ **Select the correct spin to extract max. amount of water**

I save a lot of energy when the **laundry** has been **spun** at **minimum 800 rpm**. Higher spin speeds extract even more water, shortening the drying times and reducing energy consumption.

### ■ **Good ventilation in the laundry room**

The temperature in the room where the tumble dryer is located should **not exceed 35 C** to ensure the most economical operating conditions.

### ■ **The loads should have the correct weight**

The most economical way to dry is to keep to the **recommended weights** in the programme charts. The following may help you to assemble the right load more easily:

#### **Laundry weight:**

Guide values for cotton (dry weight)

Bathrobe	1200 g
Overall	300–600 g
Duvet cover	700 g
Sheet	500 g
Blouse	100 g
Towel	200 g
Tea towel	100 g
Shirt	200 g
Pillow case	200 g
Nightdress/pyjama	200–500 g
Tablecloth	200–250 g
Underwear	250 g

### ■ **Clean the fluff filter**

My fluff filter must be cleaned after each drying cycle. A fluffed up filter requires longer drying times and thus more energy.

The packaging material meets ecological requirements and can be easily disposed of or can be burned safely in the municipal incinerators.

To the materials: the plastics can be recycled and are marked as follows:

> **PE** < for Polyethylene, e.g. the outer wrapping and the bags inside.

> **PS** < for blown (CFC free) Polystyrene, e.g. the fillers

The cardboard parts have been manufactured from recycled material and should be taken for recycling again.

**Information on  
the packaging  
material of the  
appliance**





## Important recommendations for drying

### Wool and down-filled articles

Do not dry any wool or wool mixtures – these fabrics will felt. Down-filled articles such as eider-downs should not be dried in a tumble dryer unless recommended by the manufacturer of the article. Linen should only be dried in the tumble dryer if the manufacturer of the article recommends this, tumble drying tends to make the surface of the article rough.

### Textile care labels

Check whether the manufacturer of the garment has recommended tumble drying on the care label in the garment. You will find the following symbols in the garments.

-  May be tumble dried
-  Can be tumble dried on high heat setting
-  Tumble dry on low heat setting
-  Do not tumble dry

Laundry which has been marked with the symbol  is not suitable for drying in a tumble dryer.

### Special care programme/S-button

Heat sensitive materials such as acrylics with care label  are recommended to be dried in the Special care programme (press button SPECIAL CARE).

### Creasing

Easy-care fabrics tend to crease when over-dried. We recommend to use programme 7.

The fuller the drum the more creasing will occur. We recommend to reduce the load to 1.5 kg or less for minimum iron fabrics particularly those which are large or light in weight. For loads below 1.5 kg we recommend that you use a time controlled drying cycle as the electronic sensor cannot accurately sense small loads.

### Knitted cotton

These garments tend to shrink during tumble drying, remember this when buying new articles and choose size accordingly. Take care not to over-dry these garments and do not choose the programme "extra-dry". Shrinkage should however be minimal if good quality garments are chosen. We recommend the "cupboard dry" EASY CARE setting

### Starched laundry

Starched laundry can also be tumble dried. To achieve the starched effect use double the dose of starch. Wipe my drum with a damp cloth after drying to remove any starch residues.

### Spin laundry before tumble drying

Spin your laundry well before tumble drying. We recommend at least 800 rpm. Higher spin speeds will reduce the drying times and the energy consumption. For easy-care fabrics choose the special spin which you will find on your washing machine for these fabrics.



Close zips and any buttons and tie loose apron strings etc. to prevent laundry from tangling.

Turn double layered garments such as anoraks inside out to get a more even drying result.

Do not dry new dark coloured garments together with light coloured ones to prevent discolouration of garments.

## **Preparing the laundry**

## Appliance description

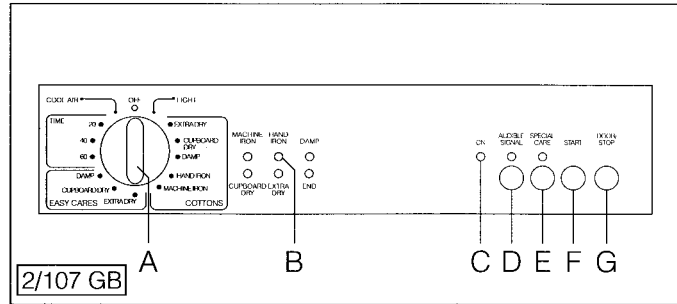

### Features

- A** Programme selector
- B** LED indicators for degree of dryness and programme end
- C** Machine “ON” light
- D** Acoustic “programme end” indicator
- E** Button for special care programme
- F** Start button
- G** DOOR STOP button (for any depressed buttons)

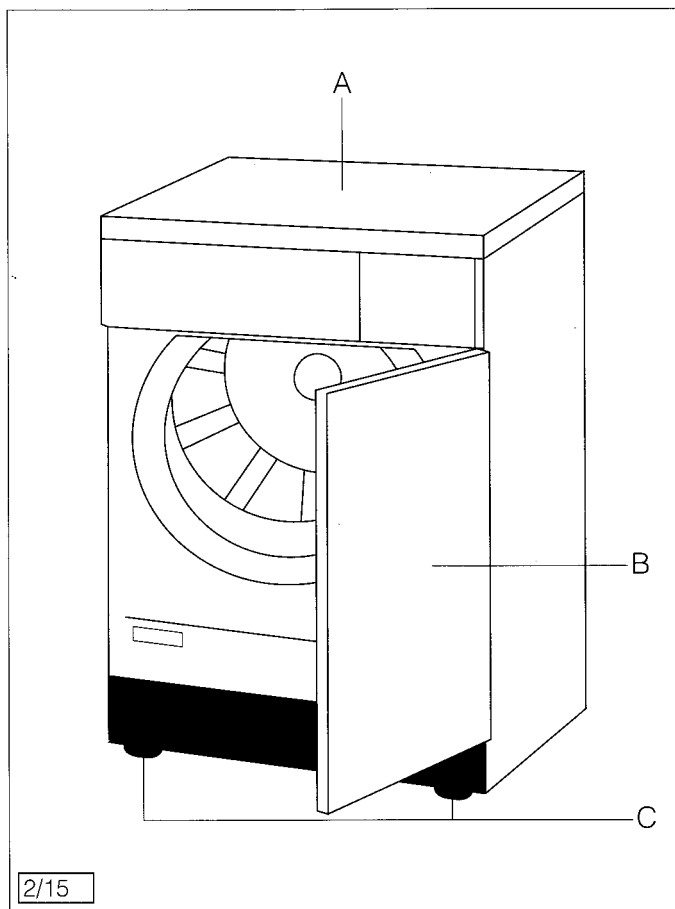

**A** Removable worktop

**B** Appliance door is opened by pressing door release button (when machine is connected to electricity) or by using override

**C** 4 height adjustable feet (front and rear)

## Features

## Before starting to dry

### Sorting the laundry

Sort your laundry as follows:

- cottons and linens
- easy-care fabrics
- dark coloured laundry
- light coloured laundry

Check that the laundry is recommended for tumble drying.

Due to felting do not dry any woollen garments, wool mixtures, hand-knitted wool garments or any garments which incorporate a proportion of wool.

### Prepare garments for tumble drying

#### Empty pockets

Remove any metal articles from laundry, e.g. paper clips, safety pins, coins etc.)

Close all buttons, zips, hooks and eyes. Tie loose belts and apron strings.

## How to tumble dry correctly (Brief instructions)

### What to do before drying

1. Sort the laundry
2. Select the programme
3. Open loading door
4. Loosen laundry and place in drum
5. Close the loading door
6. Select option buttons
7. Press start button

### At the end of the programme

8. Open the loading door
9. Remove the laundry
10. Switch off the appliance
11. Clean the fluff filter
12. Close the loading door

## Loading the laundry

There are two ways of opening the loading door:

### 1. Press the DOOR/STOP button

To open the door this way the dryer has to be connected to the electrical supply. This means, the machine has to be plugged in, socket switched on and the programme selector has to be moved from the off (0) position. The machine "on" lamp lights up.

### 2. Override

If not connected to the electrical supply (e.g. the machine "on" light is **off**), press the door half-way up on the left-hand side to open.

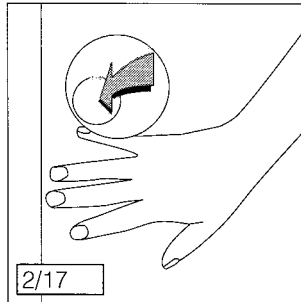

You can use this method of opening the door any time you want regardless of whether the machine is connected to the electrical supply.

Loosen the laundry before loading into the tumble dryer. This will cut down on drying times and reduce creasing due to tangling. If you keep to the recommended weights for the different loads this ensures economical operation. But do not overfill the dryer, this will increase the drying, the energy consumption and result in excessive creasing.

You can open the loading door at any time during the programme to add or remove laundry. To open the door press the DOOR/STOP button or use the Override.

### Take care when adding or removing laundry

The inside of the drum and the laundry may be hot – so do take care when adding or removing laundry during a drying cycle.

**Before you re-start** the machine you have to **re-select the Option buttons (Special Care button or acoustic programme end signal)** as they will have been cancelled when the door was opened. This does not apply if you use the Override to open the door. Close the loading door and press the Start button and the drying cycle will continue.

## Opening the loading door

## Loading the machine

## Adding and removing of laundry

## Selecting the drying programme

### Drying time selector

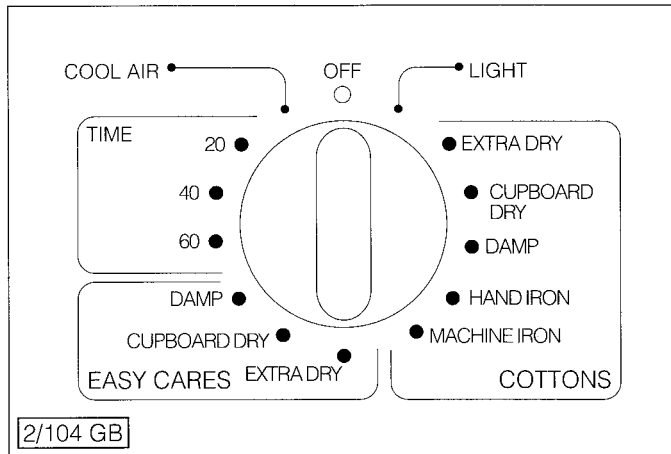

The programme selector can be turned clockwise to any setting. It has 3 functions:

- The drying time selector switches the machine "on" light on and off.
- You use the drying time selector to select the drying time required. To do this turn the drying time selector clockwise until the time (minutes) you wish to select are under the marker point. For drying times consult the "Guidelines for Drying Times".
- The drying time selector switches the light inside the drum on and off.

### Electronic programme stage indicator

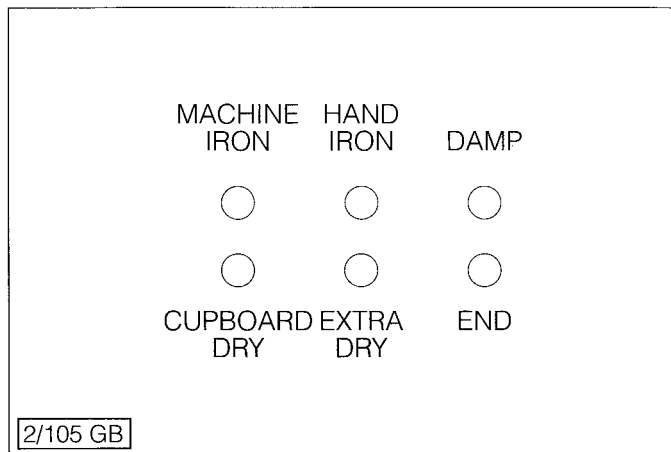

The dryer has an electronic programme stage indicator for programmes 1 – 8. As the laundry reaches a certain degree of dryness the relevant symbol lights up. On completion of the drying programme the symbol END also lights up.

This visual control offers you the advantage of removing individual articles at different degrees of dampness for ironing. If you do remove laundry during drying take care as both the drum and the laundry will be hot. If none of the indicators are on, the machine has not yet reached any of the stages.

By combining the main programmes on the programme selector with the available buttons I offer maximum programming flexibility.

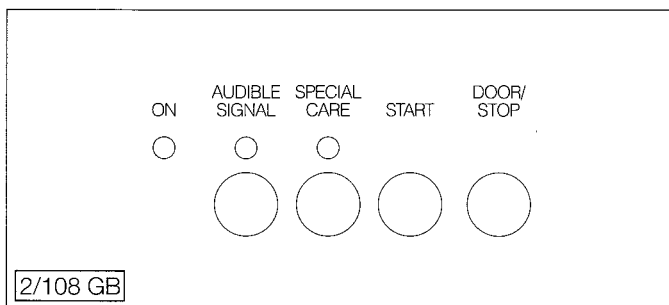

A red indicator appears above the depressed button.

For this button to function you need to connect the dryer to the electrical supply and turn the programme selector to a setting. The machine “on” lamp lights up. Now press the DOOR/STOP button to open the loading door.

If not connected to the electrical supply, press the door half way up on the left-hand side and the door springs open. If the door is hinged on the left-hand side then press the door on the right-hand side.

If you press the DOOR/STOP button during a drying cycle, the drum stops rotating when the door springs open. At the same time **any depressed buttons are cancelled**. This does not apply if the door has been opened using the Override.

To continue the programme re-select the buttons required and press the Start button.

To cancel any depressed buttons, press the DOOR/STOP button. The loading door automatically springs open.

## The buttons and their functions

### DOOR/STOP button

**START button**

Press this button to start the programme.

**SPECIAL CARE  
button**

When you press this button the drying temperature is reduced. You can dry delicate fabrics such as acrylics or other delicate fabrics which bear the care label . Due to the lower heat the drying times are somewhat longer. Selecting the SPECIAL CARE-button is only economical for loads of 1 – 2 kg. For this reason we only recommend the use of this button for EASY CARES: EXTRA DRY, CUPBOARD DRY and SLIGHTLY DAMP (see programme chart).

**AUDIBLE SIGNAL  
button**

Press this button if you wish the programme end to be indicated by an acoustic signal. The signal can be heard intermittently for 30 minutes. During this period the drum rotates intermittently (see automatic anti-crease cycle).





# Programme Chart

Brief programme instructions are found on the front of the machine.

## Programmes for cottons/linens (capacity up to 5 kg)

Degree of Dryness	Type of Laundry/Fabric
Extra Dry	Heavy weight or multi-layered textiles
Cupboard Dry	Textiles medium weight, articles not made up of multi-layers
Damp	Lightweight materials requiring ironing
Hand iron	Normal cotton and linen articles
Machine iron	Cotton and linen articles, to be ironed by rotary ironer or starched laundry

## Programmes for easycare fabrics: cotton/polyester mixtures and synthetics (capacity 1 – 2 kg)

Degree of Dryness	Type of Laundry/Fabric
Extra Dry	Heavy and multi-layered textiles
Cupboard	Lightweight materials which do not require ironing
Damp	Lightweight synthetics and cotton/polyester mixtures requiring ironing

### Information for Test Institutes:

For the test according to DIN 44986 the following programme selections should be used:

Programme A (5.0 kg) Programme Selection Cupboard dry  
Programme B (5.0 kg) Programme Selection Hand iron  
Programme C (2.0 kg) Programme Selection Cupboard dry

### Airing Programme

Programme Selection Cool A, R

You can use this programme to air textiles or to tumble out slight surface creasing. Slightly damp the creases and tumbling in cold air will help to smooth out the creases.

<b>Laundry Examples</b>	<b>Use S-Button</b>	<b>Electrical Consumpt. (kWh)*</b>	<b>Time in Min.*</b>
Towelling material, bath robes	No		
Towelling garments, cotton bed linen, kitchen towels, cotton underwear	No	3.2	75
Cotton shirt and underwear	No		
Sheets and pillowcases, tablecloths	No	2.7	65
Cotton sheets and pillow cases, tablecloth	No		

\* Values refer to 5 kg cotton laundry which has been spun at 800 rpm.

<b>Laundry Examples</b>	<b>Use S-Button</b>	<b>Electrical Consumpt. (kWh)*</b>	<b>Time in Min.**</b>
Sweatshirts, bed linen and table linen	Yes		
Easycare fabric shirts, table linen, baby clothes, socks and underwear	Yes	0.9	30
Bed and table linen, easycare fabric shirts and blouses	Yes		

\*\* The values refer to 2.0 kg laundry which has been spun in the easycare fabric spin programme of the washing machine.

### **Drying by time**

You can select a drying time between 20 and 60 minutes for small loads under 1 kg or indeed for single garments.

**If a particular programme does not give you the result you require choose another programme number.** Laundry will get progressively dryer the lower the programme number chosen.

## Cooling phase and anti-crease cycle

Shortly before the programme finishes the laundry is cooled down. If the laundry is not removed at the end of the programme the anti-crease cycle commences automatically. It lasts for 30 minutes and the drum rotates intermittently. This ensures the laundry remains loose and fluffy and does not pick up any creasing. The laundry should really be taken from the machine at this point to prevent creasing.

## Programme end

Turn the programme selector to the 0 (off) position. The interior light and the machine "on" light will go out.

## Switching off the appliance

## Indicating operating errors

Sometimes slight operating errors cause the machine not to function the way it should. To help you find out what went wrong the control panel indicates certain operating mistakes you may have made on the programme stage indicator and on the illuminated indicators.

1. The indicator END lights up shortly after starting without indicating the degree of dryness or dampness and the drying cycle has been stopped.

**Cause:**

You have loaded too little laundry into the machine for the programme you have chosen.

**Remedy:**

Choose a programme for small loads or use a time controlled drying cycle.

2. The indicator END flashes and the acoustic end-of-programme signal starts up and cannot be cancelled by pressing the relevant button.

The required degree of dryness could not be reached within 4½hours and the drying programme has been stopped.

**Cause:**

You depressed the SPECIAL CARE-button for a load which was too large.

**Remedy:**

Check which programme you should have chosen for the load. The SPECIAL CARE-button is only suitable for small loads and heat sensitive fabrics, e. g. it is recommended for Easy-cares, damp, cupboard dry and extra dry.

By opening the loading door or switching off the machine all "operating error" indicators are switched off although the cause of the operating error has still to be corrected. The operating errors will be indicated again when the next drying programme is started.

If you have followed the above procedures but the machine is still not operating please contact AEG Service quoting the E-No and the F-No (see section on Service).

## Cleaning the fluff filter

Fluff collects in the fluff filter on the inside of the loading door. (The amount of fluff breaks down as follows according to HEA, Frankfurt, the main advisory body for electrical appliances: (70% due to wear, 20 % due to washing and 10 % due to tumble drying). To ensure unimpeded airflow it is necessary to clean my fluff filter after each drying cycle. To clean the filter lift up the coarse filter and remove fluff from fine filter.

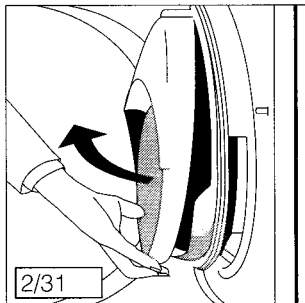

Fluff is more easily removed if you damp your hand slightly or use a damp cloth. After cleaning the fine filter, fold down and clip in coarse filter.

## Cleaning, Care and Maintenance

### Cleaning the drum

If the required degree of dampness or dryness is no longer reached, e. g. the laundry is either too dry or too damp an almost invisible film may have formed on the inside of the drum and the electronic sensors are unable to sense accurately. Clean the inside of the drum and the lifters with a cloth and vinegar.

### Cleaning of the controls and control panel

Controls and control panel must not be cleaned with any furniture polish, household cleaners or abrasive cleaning materials. Should cleaning be necessary use a soft damp cloth.

## If you think your machine is not working properly...

### ... the appliance is not working

- Has the plug been inserted into the socket?
- Have you selected a programme?
- Have you pressed the start button?
- Have you closed the loading door?
- Is the fuse in working order?

### ... the drying result is unsatisfactory

- Have you selected the correct programme?
- Does the programme stage indicator signal an operational error?
- Have you cleaned the fluff filter?
- Have you used the recommended weight for the programme?
- Has the laundry been spun sufficiently to extract water?
- Has a hardly visible film formed on the drum interior or the lifters?

### ... the drum illumination does not work?

- Has the plug been inserted into the socket?
- Have you turned the programme selector from the 0 (off) position?
- Is the bulb still in operational order or is it due for replacement?

Use only 10 W replacement bulbs available from AEG Spare Parts Department under product number ET-No. 647 078970.

**Important:** Before changing the bulb unplug the appliance or switch off at the power socket.

## Optional Extras

The following items can be obtained as optional extras through your AEG stockist:

You can combine me with a LAVAMAT washing machine of the current or the previous range to make a space saving washer/dryer combination by using one of the two available stacking kits:

1. Stacking kit with pull-out shelf to rest your laundry basket E-No. 607 899 966
2. Stacking kit without pull-out shelf E-Nr. 607 899 969

You can build me under a continuous worktop either with my own worktop in place or you can remove my existing worktop. In this case you must fit an earthed cover plate available from AEG Spare Parts Department under the product number ET-No. 647 405 423.

**Stacking kit to stand Lavatherm tumble dryer on Lavamat washing machine**

**Building under a continuous worktop**

## Service

We would like to point out that repairs are not free of charge during the warranty period if they are due to a user error, misuse or abuse of the appliance or if advice contained in our literature accompanying the machine has not been followed (see also our warranty conditions).

If you do not find any information in this booklet as to how to rectify a fault please contact AEG Service quoting the E-No. and the F-No. of the appliance which can be found on the rating plate.

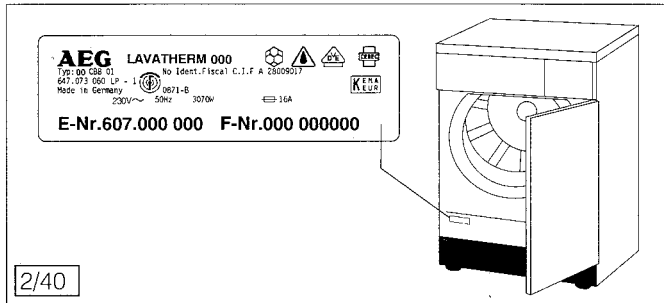

These numbers enable the Service Department to prepare as far as possible any spare parts required to rectify the fault on first call. This may save you money.

Transfer the E-No. and the F-No. into the space provided below for easy reference.

**E-No.** .....

**F-No.** .....

### AEG Service Locations in the United Kingdom

#### AEG UK Limited, Head Office

217 Bath Road  
Slough. Berks. SL1 4AW  
Tel.: 0753 872506  
Telex: 847541  
Telefax: 0753 512271

#### AEG Northern Service Centre

Unit 20, Haigh Park  
Haigh Avenue  
Stockport  
Gt. Manchester SK4 1QR  
Tel.: 061 487 2205  
Telefax: 061 474 1191

#### AEG Scottish Service Centre

Block 11, Unit 1  
Dundyvan Industrial Estate  
Coatbridge  
Lanarkshire ML5 4AQ  
Tel.: 0236 440387  
Telefax: 0236 440256

### Service Appointments

Bristol (call diverted to Slough) 0272 252880  
Norfolk (call diverted to Slough) 0603 765515



# Technical Data

## Dimensions

With worktop:

Height: 85.0 cm

Width: 60.0 cm

Depth: 60.0 cm

Without worktop:

Height: 82.0 cm

Width: 59.5 cm

Depth: 57.0 cm

## Connection

Information relating to electrical connection is given on the rating plate and in this booklet in the relevant section.

Please ensure that the voltage and current indicated on the rating plate agrees with the voltage of your electricity supply.

## Capacity

Depending on the programme chosen: up to 5 kg

Electricity consumption: 5 kg cotton spun at 800 rpm

programme cupboard dry 3.5 kWh

## Adjustable height

+ 1 cm / - 0.4 cm

Depth with door open: 116.5 cm

Weight: 51 kg

Suitable for: domestic use

Ambient temperatures: + 5 ° C to + 35 ° C

The appliance is radio-interference suppressed in accordance with EN 55014 DIN VDE 0875 part 1, EC Directive 82/499 EC, 87/308 EC as well as the Standard relating to the Retroactive Effect of the Mains Supply EN 60555 part 1 - 3/DIN VDE 0838 part 1 - 3, June 1987.





AEG Hausgeräte AG  
Postfach 1036  
D-90327 Nürnberg

© Copyright by AEG

H 244 295 040 – 09950.5/26 –

**AEG Domestic Appliances Ltd**  
Customer Care Department  
55-77 High Street  
Slough  
Berkshire SL1 1DZ  
Telephone: 08705 350350