

# Condenser Tumble Dryer LAVATHERM 720

Operating Instructions

---

# Please read and keep your operating instructions

---

The information in this booklet will help you to get the best from your very efficient LAVATHERM tumble dryer.

Do not call out a service engineer for any user related information contained in the booklet — such a call is not free of charge.

---

## Contents

---

	Page
Illustrations (unfold for easy reference)	4—5
Your LAVATHERM	6
Safety information	6
How to save energy	7
Do's and don'ts to get the best results	8
How to use your LAVATHERM	9—10
Programme chart	11
Machine transport and maintenance	12
If you think your machine is not working properly	13
Service	13
Optional extras	14
Installation	14
Electrical connection	15
Technical Data	16





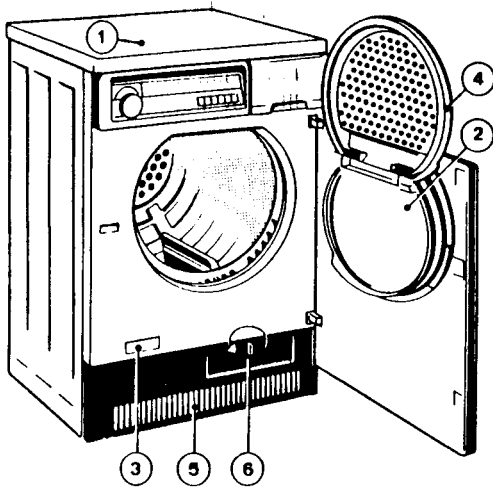

Fig. 1

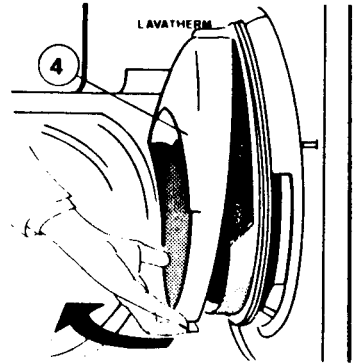

Fig. 2

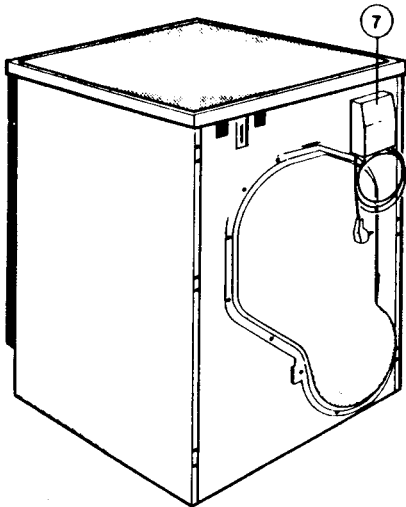

Fig. 3

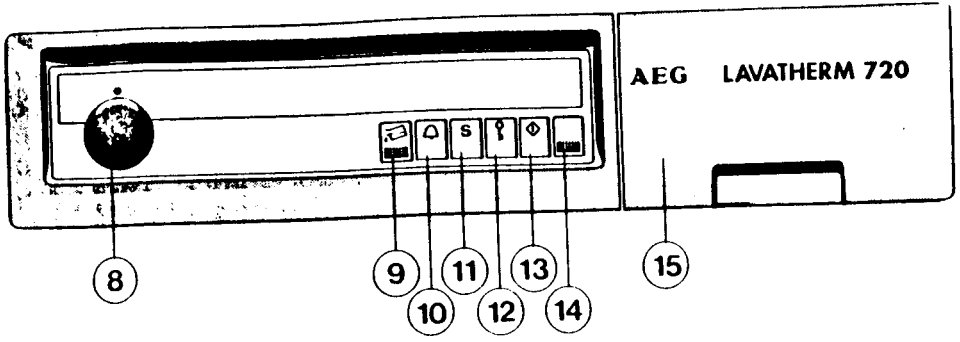

Fig. 4

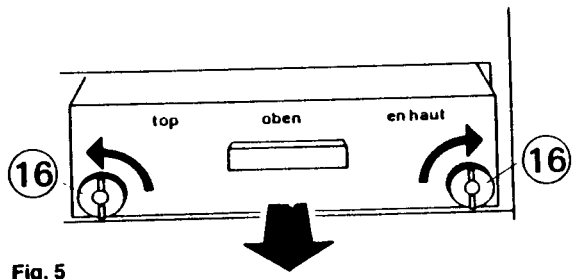

Fig. 5

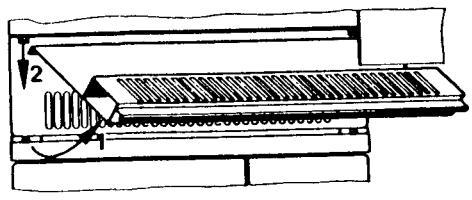

Fig. 6

---

# Your LAVATHERM

---

## Front

- Fig. 1/① Worktop (removable)
- Fig. 1/② Fluff filter
- Fig. 1/③ Rating plate (E-No. and F-No.)
- Fig. 1/④ Cover to fluff filter (lift up)
- Fig. 1/⑤ Air vent
- Fig. 1/⑥ Access flap to heat exchanger

## Side/rear

- Fig. 3/⑦ Electrical lead

## Control Panel

- Fig. 4/⑧ Drying time selector
- Fig. 4/⑨ "Empty condensed-water container" indicator
- Fig. 4/⑩ Acoustic "programme end" signal
- Fig. 4/⑪ Button for temperature sensitive fabrics
- Fig. 4/⑫ Door release button
- Fig. 4/⑬ Start button
- Fig. 4/⑭ Pilot light
- Fig. 4/⑮ Condensed-water container

## Heat exchanger (built-in)

- Fig. 5/⑯ Locking discs

---

## Safety information

---

### Attention!

- Only dry in the tumble dryer articles which have been washed in water. Do not dry articles which have been cleaned with inflammable liquids, e.g., dry cleaning fluids or stain removers (benzine, alcohol, etc.) — there is a risk of fire if such articles are dried in the tumble dryer.
- Do not dry articles containing foam rubber or rubber-like materials in the tumble dryer (risk of fire).
- Remove all items which can catch fire (lighters, etc.) from the laundry.
- Always close the loading door to prevent children from leaning or sitting on the door and tipping the dryer over.
- The back panel of the dryer will get hot during drying. This is normal — do not touch.
- Keep the area around the dryer free of fluff.
- If a dryer is replaced with a new one ensure that the door lock of the old dryer is destroyed to prevent playing children from locking themselves in the dryer and endangering their lives.

---

## How to save energy

---

The LAVATHERM 720 is a very economical dryer — even more so when you follow the hints below:

- Spin the laundry in a washing machine with high water extraction (e.g., at least 800 rpm).
- The room in which the dryer is sited should be well ventilated and the temperature should not exceed 35 °C during drying to ensure economical drying.
- The dryer works most economically with the load sizes as recommended on page 11. The following chart may help you in assembling the loads.
- Clean the fluff filter after each drying programme. A blocked fluff filter means longer drying times and high energy consumption.
- Clean the heat exchanger. Further energy can be saved by cleaning the heat exchanger regularly (see page 12).

### Guide to weights of laundry:

---

Bath Robe	1200 g
Overall	300—600 g
Double sheet	700—1000 g
Single sheet	450—700 g
Pillow case	100—200 g
Bath towel	450—700 g
Hand towel	200 g
Tea towel	100 g
Shirt	200 g
Pyjamas	350—450 g
Table cloth	300—450 g
Underwear	250 g
Blouse	100 g

---

---

## Do's and don'ts to get the best results

---

**Don't** dry woollens or wool mixtures in a tumble dryer (risk of felting).

**Don't** dry articles which carry the symbol  on the care label, they are not suitable for machine drying.

**Don't** dry laundry which has not been spun in a washing machine.

**Do** check the care labels on the clothes if they are suitable for tumble drying.

You may find the following tumble drying instructions on the clothes:



Future drying labels  
normal drying programme



Future drying labels "S" button depressed  
for temperature sensitive articles



Current drying label  
tumble drying beneficial



Do not dry in a tumble dryer

- If easy-care fabrics are over-dried, creasing will occur. Do not select excessive drying times (see chart on page 11 for drying times).
- We recommend that you dry easy-care fabrics, delicates and acrylics (if they are recommended for machine drying) with the "S" button depressed.
- Tricot articles tend to shrink during tumble drying, remember this when buying new articles and choose size accordingly.
- Starched laundry can also be tumble dried. To achieve the starched effect use double the dose of starch.
- Do spin laundry well before tumble drying (at least 800 rpm).
- Close zips and tie loose apron strings, etc., to prevent tangling.
- Do turn multi-layered garments (nylon outer, cotton inner) inside out to achieve a more even drying result.



---

# How to use your LAVATHERM

---

## Operating and indicator controls

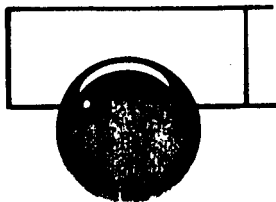

### Drying time selector

(Fig. 4/⑧)

The drying time selector controls 3 functions:

- To switch the appliance **on and off**, indicated by the on/off of the pilot light.
- To choose the drying time the rotary control must be turned clockwise only. Drying time guidelines (in minutes) are given on page 11.
- To air laundry, turn drying time selector to symbol  (approx. 10 minutes tumble i cold air).



---

### Door release button

(Fig. 4/⑫)

Press this button to open the loading door.



---

### Start button

(Fig. 4/⑬)

Press this button to start the selected programme.



---

### Button for temperature sensitive materials

(Fig. 4/⑭)

Press this button if you wish to dry with lower heat (for recommendations see page 8).



---

### Acoustic signal

(Fig. 4/⑯)

Press this button if you wish the programme end to be indicated by an acoustic signal. The signal can be heard intermittently for 30 minutes.

---

### To switch off the machine

Turn drying time selector to "0".

---

---

## How to use your LAVATHERM

---



### **"Empty the condensed-water container" indicator (Fig. 4/⑨)**

When the condensed-water container is full the machine interrupts the drying programme and the indicator lights up — empty the container. As soon as the empty container is inserted the machine continues with the drying programme.

---

### **Adding and removing clothes during drying**

To add or remove laundry during drying press the door release button. Take care as the laundry in the drum and the drum itself may still be hot. Close the door again and press the start button.

**The programme does not continue until you have pressed the start button.**

---

### **Cooling phase and anti-crease cycle**

Shortly before the programme finishes the laundry is cooled down. If the laundry is not removed at the end of the programme the anti-crease cycle commences automatically. It lasts for 30 minutes and

the drum rotates intermittently. This ensures the laundry remains loose and fluffy and does not pick up any creasing. At the end of the anti-crease cycle the machine switches off automatically.

---

### **Cleaning the fluff filter**

Fluff which adheres to the laundry during line drying is removed from the clothes during tumble drying and collects in the fluff filter.

**The fluff filter has to be cleaned after each drying programme.**

The fluff filter is located on the inside of the loading door. Lift up the filter lid (see Fig. 2/④) and remove the fluff from the filter.

---

### **Emptying the condensed-water container**

Empty the condensed-water container (Fig. 4/⑯) after each drying programme. The condensed-water container is located on the right of the control panel.

If the machine has been adapted to discharge the condensed-water into a drainage facility the condensed-water container does not have to be emptied.

---

## Drying time guidelines

Programme	Type of laundry	Quantity kg	Water extracted at spin speeds of (rpm)	Time (approx.) mins.	
				Normal progr.	"S" but- ton progr.
Cupboard dry	Cottons/linens	5.0	650 800 1000 1200/1400 2800*	105 95 85 80 60	
		2.0	650 800 1000 1200/1400 2800*	50 45 40 40 30	100 90 80 80 60
	Easy-cares fabrics, Synthetics, cottons/synthetic mixtures	1.5**	Short spin	30	55
Ironing damp	Cottons/linens	5.0	650 800 1000 1200/1400 2800*	80 70 60 55 40	
		2.0	650 800 1000 1200/1400 2800*	40 35 30 30 25	80 70 60 60 40
	Easy-cares fabrics, Synthetics, cotton/synthetic mixtures	1.5**	Short spin	25	45

\* Spin dryer

\*\* Smaller capacity to reduce creasing

Use shorter or longer drying times for smaller or larger quantities not listed in the chart.

### Information for test institutes

For tests according to DIN 44 986 use the following programme selections:

Programme A	(5.0 kg)	90 mins.
Programme B	(5.0 kg)	70 mins.
Programme C	(1.5 kg)	30 mins.

---

## Machine transport and maintenance

---

- The heat exchanger should be cleaned after approximately 100 drying programmes (approximately every 6 months). To clean the heat exchanger remove it from the machine as follows:

1. Open access flap to heat exchanger (Fig. 1/⑥) by turning the lever on the flap to the left — flap springs open.
2. Unlock heat exchanger by turning the two locking discs (Fig. 5/⑨) a quarter turn in the direction of the arrows.
3. Pull out heat exchanger (it may be necessary to lift it up firmly by the handle).

Clean the heat exchanger by rinsing through with clean water using a hand held shower. Do not use any other cleaning materials, pointed objects or tools of any kind to get inbetween the slots to prevent damage to the heat exchanger. Make sure that the draining slots at the back of the heat exchanger are also clean.

Insert the heat exchanger using the reverse sequence. Make sure it is inserted the right way up — with the words "top — oben — en haut" at the top.

- **Cleaning the heat exchanger if the dryer is stacked on an AEG washing machine.**

Remove the plinth as follows:

1. Unclip the plinth cover at the base by pulling forward and then unlock the top (see Fig. 6).
2. Unlock the access flaps by turning the lever to the left and remove the heat exchanger.
3. Re-insert the heat exchanger after cleaning, close the access flap, hook-in plinth cover at the top and press at the base until it snaps into position.

- **Controls and control panel** must not be cleaned with any furniture polish, household cleaners or abrasive cleaning materials. Should cleaning be necessary use warm water only.

- Should the machine be tilted during transportation the **over-flow protector** may be activated through residual water in the machine. The appliance cannot be started before the residual water is removed by tilting the machine 45° backwards. Place a floor cloth underneath to absorb the water.
-

---

## If you think your machine is not working properly

---

... If the appliance is not working:

- Have you pressed the start button?
- Have you selected a drying time?
- Have you closed the loading door?
- Has the plug been inserted into the socket?
- Is the fuse in working order?
- Has the condensed-water container been emptied and inserted correctly?
- Has the overflow protector been activated (see page 12)?

... If the drying result is unsatisfactory:

- Have you selected the correct drying time?
- Have you cleaned the fluff filter?
- Have you used the recommended load capacity?
- Has the laundry been spun sufficiently to extract water?
- Is the air vent clear?

---

## Service

---

We have listed the faults which you can rectify yourself under "If you think your machine is not working properly ..."

We would like to point out that repairs are not free of charge during the warranty period if they are due to a user error, misuse or abuse of the appliance or if advice contained in our literature has not been followed (see also our warranty conditions).

If you do not find any information in this booklet as to how to rectify a fault please call AEG Service.

When calling Service quote the "E" and "F" numbers of your appliance which you will find on the rating plate (Fig. 1/③).

Transfer these numbers from the rating plate into this instruction booklet.

E No. \_\_\_\_\_

F No. \_\_\_\_\_

These numbers enable the Service Department to prepare as far as possible any spare parts required to rectify the fault on first call.

**This may save you money.**

**Our electrical appliances conform with the relevant safety regulations. Repairs must only be carried out by AEG Service Engineers or AEG appointed Service Agents. Repairs carried out by unauthorised personnel can result in considerable safety hazards to the user.**

---

## Optional extras

---

The following items can be obtained as optional extras through your AEG stockist.

■ **Stacking kit (washing machine and tumble dryer)**

To stack the dryer on a current AEG washing machine you require stacking kit: TRZ 953 — E No. 607 899 953.

To stack the dryer on an older 5 kg AEG washing machine you require stacking kit: TRZ 910 — E No. 607 899 910 as well as the one above.

■ **Decor frames**

If you wish to fit a decor panel to your dryer to match the adjacent kitchen furniture you can purchase a decor frame in two colours to hold such a panel:

Brown — TRZ 911 — E No. 607 899 911  
White — TRZ 941 — E No. 607 899 941

■ The dryer can be adapted to drain the condensed water into an existing drain, sink, etc. To do this you require kit: TRZ 955 — E No. 607 899 955.

■ **Available from AEG Spare Parts Department**

If you wish to remove the worktop of the dryer in order to fit it under an existing one you need to fit a cover plate after removing the worktop — E No. 647 405 423.

---

## Installation

---

■ The machine must stand on a firm base. The 4 adjustable feet allow for small height adjustments to compensate for uneven floor conditions.

■ It is essential that the machine can draw in air through the ventilation slots (Fig. 1/⑥). These slots must not be blocked in any way. Even if the machine is built-under into a fitted kitchen the ventilation slots must be left open.

■ The loading door of the machine is hinged on the right hand side but can be changed over to the left hand side by your fitter or AEG service.

■ If possible do not site the dryer next to a gas, electric or solid fuel cooker. If it is unavoidable an insulation panel (85 x 57.5 cm) must be fitted between the dryer and the cooker. The side facing the cooker must be covered with aluminium foil.

---

## Electrical connection

---

### Please note! (For users in the UK)

#### Warning! All appliances with a 3 core lead must be earthed

Please ensure that the voltage and current indicated on the rating plate agrees with the voltage of your electricity supply. 220/240 volts — (i.e., 220/240 V AC).

Your appliance has been equipped with a mains lead with a moulded-on type plug. You must comply with the following regulations: The plug moulded on to the cord incorporates a fuse. For replacement, use a 13 amp BS 1362 fuse. Only ASTA approved or certified fuses should be used. The fuse cover/carrier must be replaced in the event of changing the fuse. The plug must not be used if the fuse cover/carrier is lost. A replacement cover/carrier must be obtained from an electrical goods retailer. If the socket outlets in your home are not suitable for the plug fitted to the appliance, then the plug must be cut off and an appropriate one fitted. When fitting the plug please note the following points:

#### Important

The wires in the mains lead are coloured in accordance with the following code:

Green and Yellow	Earth
Blue	Neutral
Brown	Live

Some appliances have a twin core mains lead, when no earth is required.

As the colours of the wires in the mains lead of this appliance may not correspond with the coloured markings identifying the terminals in your plug, proceed as follows:

1. The wire which is coloured Green and Yellow must be connected to the Earth terminal in your plug, which is marked with the letter E or by the earth symbol or coloured Green, or Green and Yellow.
2. The wire which is coloured brown must be connected to the live terminal which is marked with the letter L or coloured red.
3. The wire which is coloured blue must be connected to the neutral terminal which is marked with the letter N or coloured black.

When wiring the plug, ensure that all strands of wire are securely retained in each terminal. Do not forget to tighten the mains lead clamp on the plug. This appliance complies with the requirements laid out in the EEC Directive 76/889 and 82/499.

Voltage           220/240 V AC

Fuse rating       13 amps

See rating plate for further information.

## Technical data

<b>Dimensions:</b>	<b>With worktop</b>	<b>Without worktop</b>
	Height 85 cm	Height 82 cm
	Width 60 cm	Width 59.5 cm
	Depth 60 cm	Depth 57 cm
<b>Adjustable height:</b>	+ 1 cm / - 0.4 cm	
<b>Depth with door open:</b>	116.5 cm	
<b>Connected load:</b>	3070 W / 16 amp	
<b>Capacity:</b>	5 kg	
<b>Weight:</b>	51 kg	
<b>Usage:</b>	Domestic	
<b>Ambient temperatures:</b>	+ 5 °C to + 35 °C	

The appliance complies with DIN EN 50 006/VDE 0838 and radio interference requirements of EEC Directive 76/889/EEC and 82/499.

AEG Hausgeräte AG  
Postfach 1036  
D-90327 Nürnberg 1

© Copyright by AEG

H 244 235 340 - 0188/15

**AEG Domestic Appliances Ltd**

Customer Care Department  
PO Box 47, Newbury  
Berkshire, RG14 5XL

Telephone: 01635 572700

Fax: 01635 42970