

Wash Spin Dry  
**BENDIX**  
SUPER COMPACT

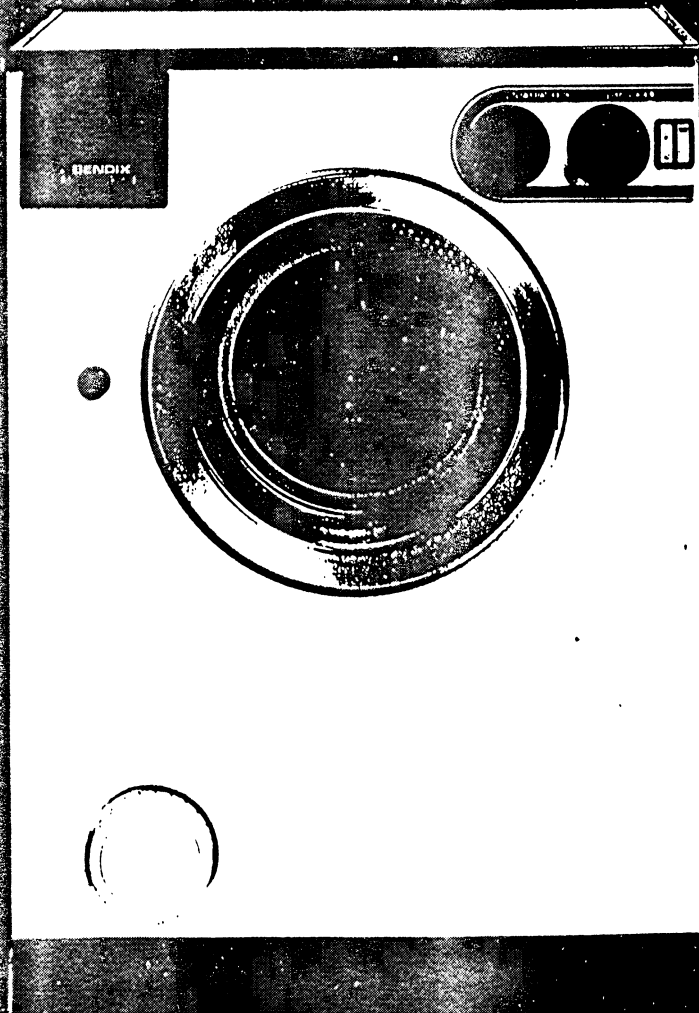

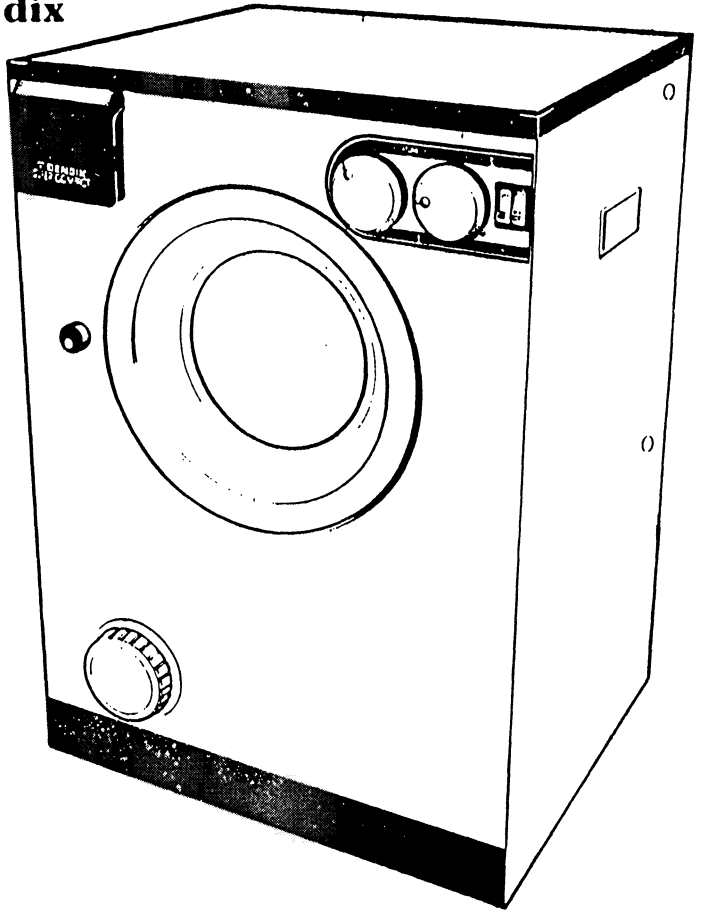

**The New Bendix  
SUPER  
COMPACT  
Model 7179**  
(Made in Austria)



You are now the proud owner of a Bendix Super Compact, which will wash, rinse and spin without you having to handle the clothes.

You will want to obtain the best results from your machine and by reading and following the instructions in this booklet you will achieve excellent results.

Please also ensure that the Installation Instructions have been carefully followed before any attempt is made to operate your machine.

If you should need any further advice or assistance please contact the Bendix retailer from whom your machine was purchased or your nearest Bendix Service Depot.

**Capacity and performance features:-**

Dry laundry maximum	5.5 lbs (2.5 kg)
Water level	13 litres (2.87 gallons)
Water supply	Cold
Cylinder volume	27 litres (0.95 cu ft)
Spin speed	550 rpm

# BENDIX

## Installation and Operating Instructions

# Model 7179

## Super Compact

Made in Austria

### DIMENSIONS

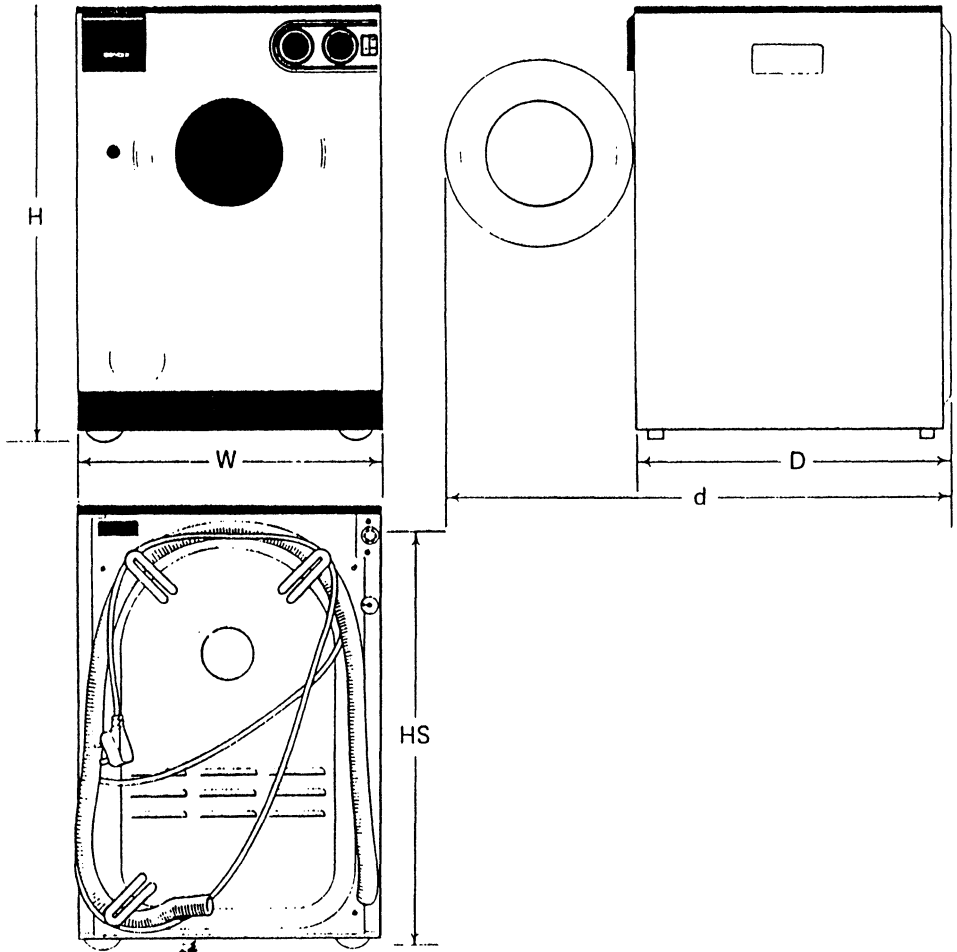

Overall height (H)	650 mm	25 3/4 in
Width (W)	460 mm	18 1/8 in
Depth - door closed (D)	460 mm	18 1/8 in
- door open (d)	700 mm	27 1/2 in
Empty machine weight	35.5 kg	78 lb

Electrical loadings:		
Heater		2 kW
Motor - tumble		100W
- spin		350W
Drain pump		100W

## SITE REQUIREMENTS

A dry, level and a relatively smooth floor, with the services brought to the appliance. A minimum of 20 mm (¾ in) clearance is required each side of the appliance to permit removal for servicing.

## UNPACKING & INSTALLATION

Remove the box, plastic cover and wooden pallet. Connect the water inlet hose.

## ELECTRICITY

Fused and earthed supply: 240V 50Hz a.c.

Mains lead: 3 core 2.7m 9ft  
Fuse ratings: 13A

Before switching on make sure that the voltage of your electricity supply is the same as that indicated on the rating plate.

### WARNING THIS APPLIANCE MUST BE EARTHED

If this appliance is fitted with a non-rewireable plug for which your socket is unsuitable the plug should be cut off and an appropriate plug fitted. The removed plug should be disposed of as insertion of the plug into a 13A socket is likely to cause an electrical hazard. If it is necessary to change the fuse in a non-rewireable plug the fuse cover must be refitted. If the fuse cover is lost or damaged the plug must not be used until a replacement is obtained. Replacement fuse covers are available from our Service Centres. It is important that the colour of the replacement fuse cover corresponds with the colour marking on the base of the plug.

**IMPORTANT-** The wires in the mains lead are coloured in accordance with the following code:

GREEN AND YELLOW	EARTH
BLUE	NEUTRAL
BROWN	LIVE

As the colours of the wires in the mains lead of this appliance may not correspond with the coloured markings identifying the terminals in your plug proceed as follows:

The wire which is coloured green and yellow must be connected to the terminal which is marked with the letter 'E' or by the 'Earth' symbol  or coloured green or coloured green and yellow.

The wire which is coloured blue must be connected to the terminal which is marked with the letter 'N' or colour black. The wire which is coloured brown must be connected to the terminal which is marked with the letter 'L' or coloured red.

The appliance must be protected by a 13A ASTA approved (BS 1362) fuse if a 13A (BS 1363) plug or a non-rewireable plug is used or if any other type of plug is used by a 15A fuse either in the plug or adaptor or at the distribution board.

If it should become necessary to replace the appliance mains cord, please ensure that the internal section of the cord is unable to touch the drum pulley wheel.

# WATER

Supply: Cold fill only.

Pressure - maximum	1000 kN/m <sup>2</sup>	140 lb/in <sup>2</sup>
- minimum	50 kN/m <sup>2</sup>	7 lb/in <sup>2</sup>
Inlet connection	¾ BSP	
Inlet hose length	1.5 m	5 ft
Inlet height (HS)	600 mm	24 in
Lead (Hd) maximum	100 m	300 ft
minimum	5 m	16 ft

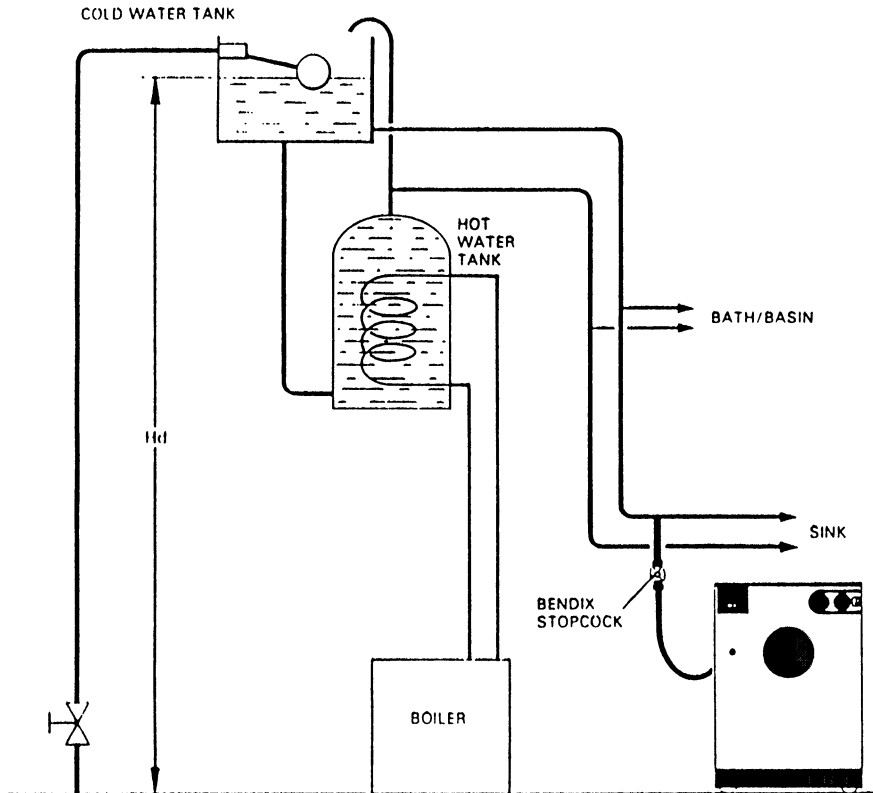

## CONNECTING TO THE WATER SUPPLY

The above diagram shows a typical domestic plumbing system. Connection can be made by fitting tee-piece and Bendix Stopcock to existing pipework. Flush out swarf and flux before using new pipe work for the first time.

## TEMPORARY CONNECTION

A good quality tap adaptor is required. When purchasing one remember that the appliance is fitted with an electrically operated valve so the inlet hose will be under pressure and the adaptor should not leak.

The inlet hose must **not** be connected to a mixer tap.

## DRAINAGE

Length of drain hose	1.5 m	5 ft
Standpipe bore (B)	40 mm	1 1/2 in
Standpipe to floor (SH) - maximum	0.9 m	36 in
- minimum	0.6 m	24 in
Preferred minimum standpipe (S)	380 mm	15 in
Suggested trap	Bottle type	
Fall to drain (F)	100 mm/m	1 in. ft

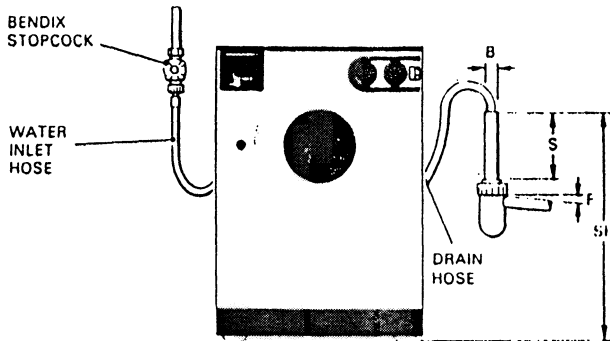

## CONNECTING THE DRAINAGE

A standpipe is recommended, with the dimensions shown.

Permanent drainage arrangements should conform to the dimensions given. There must be an airbreak or the appliance may syphon. Although the standpipe is the preferred method, the use of a specially designed trap with a hose connection is acceptable.

The drain pipe should not be pushed into the standpipe more than 100 mm.

For a temporary connection the hose may be hooked over the edge of a sink.

## OPTIONAL EXTRAS

Bendix stopcock 24042 (cold) is available.

The dimensions given in these instructions are not intended to be direct conversions between metric and imperial units. Please work in one set only.

The recommendations set out are suggestions only. All installations must comply with the requirements of local authorities or public utilities.

This appliance must be installed in accordance with the IEE regulations, in particular with regard to installation in bathrooms; if not we reserve the right to refuse to service it.

This appliance complies with EEC Radio Interference Directive 82/499 EEC.

# Diagram of Features

DETERGENT  
DISPENSER  
DRAWER

TEMPERATURE  
SELECTOR

PROGRAMME SELECTOR  
AND ON/OFF CONTROL

SPIN  
CONTROL

MAINWASH/  
PREWASH  
SELECTOR

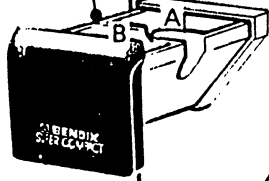

DOOR  
LOCK  
RELEASE

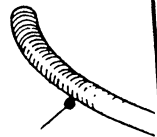

RAIN  
HOSE

RAIN  
TRAP



ROLLERS

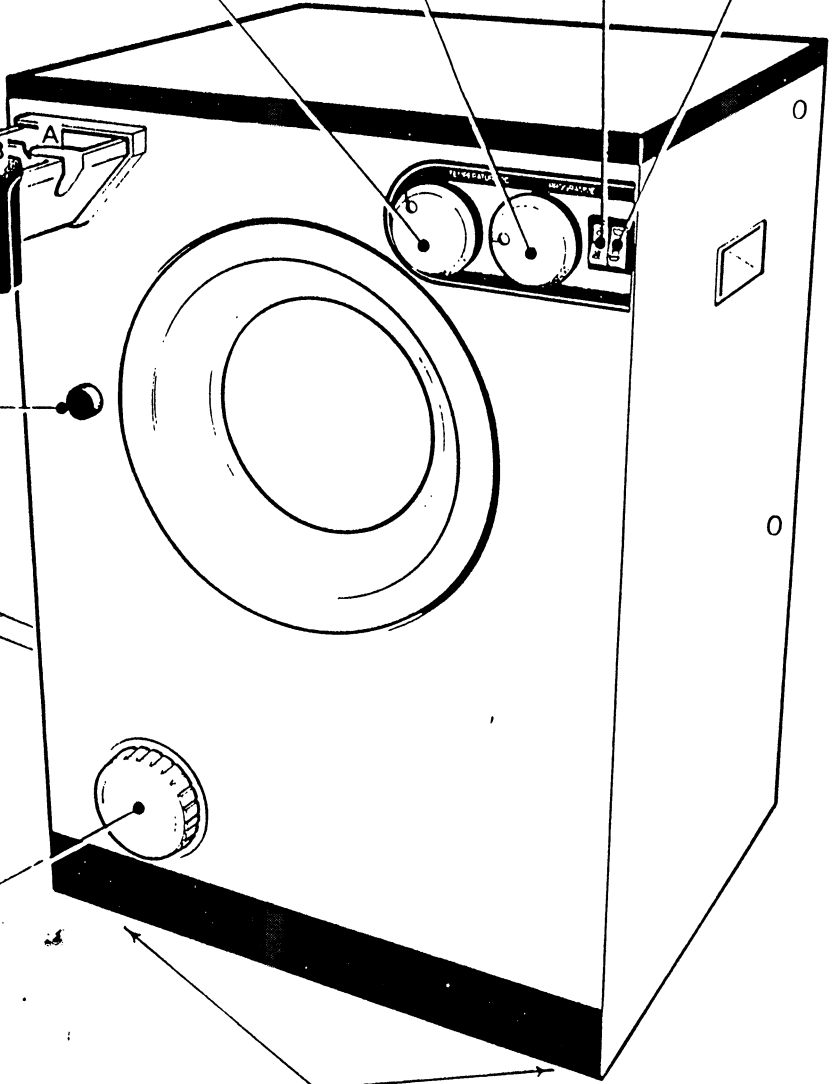



# Know your BENDIX Super Compact

## Temperature Selector

Gives a range of wash temperatures from 20-95°C to tackle all laundry problems (see programme guide on page 12).

## Programme Selector On/Off Control

Use this to select the wash programme required.

The programme selector also acts as an on/off switch. When the control is pushed in and turned to the desired programme, the machine will start to operate. To stop, push the control in again and return it to the 'stop' position.

**IMPORTANT:-** failure to push the knob in before turning will result in damage to the programme selector.



## Switches

There are two switches that provide four functions.



### Spin Control Switch

The length of the spin may be controlled or cancelled completely by the use of this control.

A shorter spin is necessary when washing easy care fabrics eg. polyester and cotton and for drip dry articles cancelling the spin will reduce creasing.

Press symbol  for 'spin' and press symbol  for 'no spin'.

### Mainwash/Prewash Selector Switch

This switch determines whether or not the machine will carry out a prewash. Because of the very efficient main wash programme, a prewash should only be necessary if the laundry is heavily soiled. Press symbol  for mainwash only and press symbol  for mainwash plus prewash. Please note that when selecting prewash, the programme selector must always be set to position 1.

## Detergent Dispenser

The detergent dispenser is so designed that detergents and conditioners will flush automatically into your machine.

It is divided into two compartments, A is for mainwash powders when a prewash programme has been selected and B is for fabric softeners such as Comfort. At the end of the wash programme any remaining water will be automatically syphoned out leaving the dispenser ready for the next wash.

## Cleaning the Detergent Dispenser

It is important that the two compartments of the dispenser are kept clean. This is made easy by removing the dispenser drawer from its housing in the machine.

To do this:

1. Pull out the drawer as far as it will go.
2. Gently squeeze the sides of the rear compartment (A) and ease forward until clear.

To clean, flush the drawer under a running tap, dry thoroughly and replace by reversing the above procedure.

## Drain Trap

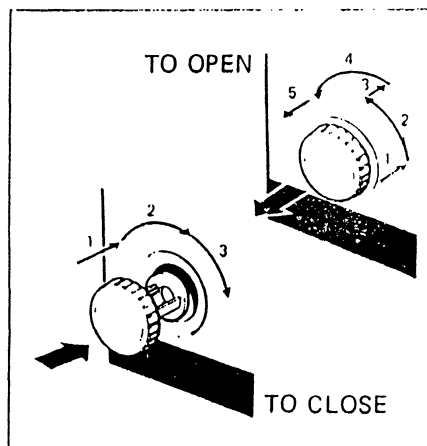

This will only require clearing if the machine stops and will not spin. Fluff will pass through without hindrance, whilst, coins, button hairpins or similar objects, will be safely caught thus protecting the pump. If it becomes necessary to open the drain screen the following procedures should be carried out.

### **Draining the Machine**

Unhook the drain hose and lay it in a shallow receptacle suitable to take the water remaining in the machine.

### **Opening the Trap**

Push the locking plug in and turn anticlockwise  $\frac{1}{8}$  turn to the first position. Then push in again and turn anticlockwise to release the plug. Remove the trap by pulling toward you.

**Note:-** The first position will allow water to trickle out slowly indicating the need for attention before finally releasing the plug.

### **Clearing the Blockage**

The item causing the blockage (a coin, button etc) will be located within the trap housing and should be removed before replacing the trap.

### **Replacing the Trap**

Reverse the procedure in 2 by turning clockwise to the first position. Push in again firmly, and make a final clockwise turn to lock.

### **Drain Hose**

Make sure that this is not kinked or the machine will not operate.

### **Door Lock**

The door incorporates a safety locking device which operates when the washing machine is spinning and spinning. Please allow 90 seconds at the end of wash programmes before pressing the door lock release.

If it should be necessary to open the door during a wash programme, first switch the programme selector to 'stop' and wait 90 seconds before opening the door.



# Using your BENDIX Compact

Always use a low sudsing detergent in your machine, e.g. Persil Automatic, as these are specially formulated to work in conjunction with your machine to give the best results.

The following quantity of powder is a guide for average water supplies. If the water is very hard more powder may be needed. If very soft less will be needed, If you are in doubt refer to the instructions on the packet.

The suds level should never rise more than halfway up the door. Too much foam will not only impede the wash action of your machine but will rise through the overflow pipe at the back of the machine and may soak the floor. If this should happen clear excessive suds by setting the programme selector to 4 to allow the machine to rinse out.

## Full Load Wash ..... 90-100g (3-3½ oz)

If you have a more heavily soiled load and decide to use the pre-wash before a main wash, place approximately two thirds of the powder in the mainwash compartment 'A' of the detergent dispenser drawer and place the remaining third amongst the soiled laundry in the drum. For mainwash only, place all the powder with the soiled laundry in the drum as described on page 13.

### Note:

An average teacup holds 75-90g (2½-3 oz).

## Fabric Softeners e.g. Comfort

All fabrics particularly towels and nappies, benefit from the use of fabric conditioners in the final rinse. Items of laundry feel softer, are more easily ironed and the clinging effect of nylon is considerably reduced.

**To Use:** Pour the conditioner into the 'additives' compartment 'B' of the detergent dispenser drawer to the level indicated on the compartment side. Under no circumstances overfill as the conditioner will immediately syphon into the machine and impair the wash results.

## Preparation Before you Wash

Many garments carry a label under the International Textile Care Labelling (ITCL) scheme indicating the correct type of wash treatment required.

You will find that this label corresponds to the Wash Chart on Page 12.

Sort your washing according to the Care Label number given on the garment, or according to the fabric and type of treatment required. Your Bendix Super Compact takes up to 2.5 kg (5.5 lb) dry weight of cotton.

If you decide to mix fabrics always use the wash programme for the most delicate fabric in the load. For example, a wash load made up with fabrics from the wash groups  $\sqrt{1}$  and  $\sqrt{2}$  should be washed on  $\sqrt{2}$ , similarly a wash load with fabrics from  $\sqrt{3}$  and  $\sqrt{4}$  should be washed on  $\sqrt{4}$  etc. White nylon and delicate items i.e. programmes  $\sqrt{3}$ ,  $\sqrt{4}$ ,  $\sqrt{6}$ , should be washed separately.

Make sure that all pockets have been emptied, zips fastened and apron strings tied. Remove pins and other small objects which could harm clothes if they become separated in the machine.

If possible make up loads of similar soiling keeping heavily soiled items separate from lightly soiled items. Heavily soiled parts such as shirt cuffs and collars may be pre-treated by brushing with a solution of detergent and water. This should be applied lightly to the right side of the garment.

- Before washing your coloured garments check that the colours are fast.
- Usually it is recommended that coloured items be washed separately from whites, but some fast dyed items, ie sheets, towels can safely be washed together with your family household linen.
- Non-fast coloured articles should be washed at the recommended temperature.

## **Stain Removal**

Most household stains come out in the normal wash, but there are some which require special treatment. See section on Stain Removal below.

When using a stain remover, follow the maker's directions carefully. Never use full strength bleach on any fabrics.

Rinse thoroughly after any special treatment. Chemicals left in fabrics can weaken or destroy some fibres. Test delicate fabrics for possible damage to fibres before tackling the stained area.

## **Stains**

### **Coffee, Tea, Fruit, Wine,**

These are usually removed in the wash. For old stains, soak, then launder in the usual way.

### **Grass, Ink, Ballpoint**

Dab with methylated spirits over a soft cotton pad, then launder in the usual way. Do not use methylated spirits on Tricel. Treat ink stains on Tricel with glycerine.

### **Tar**

Scrape off excess, dab with petrol, over a soft cotton pad. (Caution. Petrol is inflammable).

### **Scorch**

Moisten light stains and soak in glycerine then wash. If stains remain, soak in one part hydrogen peroxide to nine parts water; wash through and rinse thoroughly.

### **Iron Mould**

Soak light stains in lemon juice, press between damp cotton, repeat if necessary.

### **Grease, Fat, Lipstick Blood, Egg, Milk Cream, Meat Juice**

Treat with a proprietary grease solvent. Soak, then launder in the usual way.

### **Mildew**









Treat with peroxide. Soak (using one part hydrogen peroxide to nine parts water), rinse well. Care must be taken with coloured fabrics.

## Guide to wash load weights



Regular Wash	Sheet ... Cotton	(D)	2½ lb.	1.1 kg	
		(S)	1½ lb.	670g	
	Other than cotton	(D)	1½ lb.	670g	
		(S)	1¼ lb.	460g	
	Cot Sheet		6 oz.	170g	
	Pillowslips Cotton		4 oz.	113g	
	Others		3 oz.	85g	
	Bath Towel		1½ lb.	670g	
	Hand Towel		9 oz.	255g	
	Tablecloth Small		8 oz.	277g	
	Large		1½ lb.	670g	
	4 table napkins		6 oz.	170g	
	Personal	Shirt ... Cotton		10 oz.	283g
		Others		7 oz.	198g
Blouse ... Cotton			5 oz.	142g	
Others			4 oz.	113g	
Cotton Vest			4 oz.	113g	
Underslip			4 oz.	113g	
Panties			2 oz.	56g	
Bras			1 oz.	28g	
Pyjamas			12 oz.	340g	
Nightdress			5 oz.	142g	
Socks ... Long 2 prs.			6 oz.	170g	
Short 2 prs.			3 oz.	85g	
6 Hankies			3 oz.	85g	
1 doz. Nappies		2½ lb.	1.1kg		
Special Wash	Candlewick Bedspread				
	Double		7 lbs	3.18kg	
	Single		5 lbs.	2.27kg	
	Blanket ... Wool		4¼ lb.	2kg	
	Acrylic		3¼ lb.	1.5kg	
	Dress ... Cotton		12 oz.	340g	
	Others		12 oz.	340g	
	Sweater ... Wool		14 oz.	400g	
	Others ... Heavy		12 oz.	340g	
	Lightweight		6 oz.	170g	
	Crimplene Suit				
	H/W		3 lb.	1.36kg	
	Lightweight		2 lb.	910g	
Skirt		7 oz.	198g		

When washing fabrics which crease such as Acrilan, Orlon, Nylon, Terylene etc. load the cylinder, allowing plenty of room for the garments to move about in order to minimise creasing.



## BENDIX SUPER COMPACT PROGRAMME GUIDE

ITCL WASH CODE	FABRIC	PREWASH	SPIN	SELECT POS.	SELECT TEMP.	LOAD
	White cotton and linen	Select if required	Full Spin	1	90°-95°C	2.5 kg/5.5 lb
	Colour fast cotton and linen	Select if required	Full Spin	1	60°C	2.5 kg/5.5 lb
	White nylon sturdy synthetics	Not available	Reduced Spin, (1 minute maximum)	2	60°C	1.3 kg/3 lb
	Coloured nylon, polyester, cotton mixtures, terylene drip dry	Not available	Reduced Spin, (1 minute maximum)	2	50°C	1.3 kg/3 lb
	Non colour fast cotton and linen	Select if required	Full Spin	1	40°C	2.5 kg/5.5 lb
	Delicate fabrics	Not available	Reduced Spin, (1 minute maximum)	3	40°C	1.3 kg/3 lb
	Machine washable woollens	Not available	Full Spin	3	40°C	1.3 kg/3 lb
	Cotton articles with special finishes capable of being boiled	Select if required	No spin	1	90-95°C	2.5 kg/5.5 lb
Rinse and Spin	—		Full or reduced according to fabric	4	—	2.5 kg/5.5 lb
Spin Only	—		Full or reduced according to fabric	5	—	5.5 lb/2.5 kg

## Procedure

1. Check that your machine is plugged in and switched 'on'.
2. Check the stopcock is fully open.
3. Check that neither the fill or drain hoses are kinked.
4. Select mainwash  or mainwash with pre-wash .
5. Open the door by pressing the door release button.
6. If selecting mainwash, place half the wash load into the drum, sprinkle detergent over it and then add remainder of load.

**Please note:** when the switch is set to  detergent should **not** be placed into the detergent dispenser as it would be flushed into the drum during the final rinse.

7. If you wish to have a prewash before mainwash, place two thirds of the powder into compartment A of the detergent dispenser. The remainder of the powder should then be sprinkled over the wash load as in 6.
8. When required, fabric conditioner should be added to compartment B of the detergent dispenser.
9. Close the door.
10. Select 'Spin'  or 'no spin'  as required.
11. Select the correct wash temperature for the fabric (see programme guide on page 12).
12. Select programme required. This will start the machine (see programme guide on page 12).

## **Wash Programme**



The choice of programmes and temperatures available enables you to select the best programme for your wash load corresponding to the code of the International Textile Care Labelling Scheme (see chart on page 12). However a wider variety of programmes may also be achieved with a combination of temperature and programme selection.

## **Woollens Wash**

Do not wash Woollens in your Bendix unless the garment has been labelled 'Machine Washable'. This means that it has been especially treated to minimise shrinkage. However, it is advantageous to spin the woollen articles that have been washed and rinsed by hand as this removes most of the excess water. Dry woollens carefully to help preserve their texture and shape. After spinning remove from the cylinder, carefully pull into shape and dry flat if possible, avoiding direct heat. Do not be tempted to put woollen garments into the Tumble Dryer unless specifically marked 'Machine Wash - Machine Dry'.

## **Spin**

The spin has a special feature in that it switches from the spinning cycle back to the washing cycle if the laundry is lying awkwardly, so that the laundry can distribute itself better. This operation is repeated until the clothes are well distributed. \* See note 9, page 15.

The length of the spin maybe controlled according to the type of fabric. Fabrics carrying the care labels ,  and  should only be spun for 1 minute to avoid excess creasing. To stop the spin after the required time, switch the spin control to the 'No Spin' position.

## **After Use**

We recommend that you:

1. Turn off the cold tap to the machine.
2. Make sure that the Programme Selector is at the 'stop' position.
3. Switch off at the power point.
4. Leave the porthole door slightly ajar.
5. If your machine is not permanently installed, disconnect the hoses, remove the electric plug from socket, and coil up the cord and drain hose using the clips provide. See diagram page 2.



## What's Gone Wrong?

If your machine won't work, check the following list and make sure that you haven't overlooked anything which might prevent your Bendix from functioning. It will certainly help you and us.

1. Check that your Bendix is plugged in and switched on.
2. Check the 13 amp fuse in the plug. You could try another appliance from the same outlet in case the main fuse has blown.
3. Be sure that the cold tap has been turned on fully.
4. Have you selected the Programme?
5. Look to see if the door is fully closed. The door safety switch prevents the wash motor operating if the door is open.
6. Is your machine overloaded? If so the motor protector switch will stop the machine. If overloading is the problem simply remove some of the clothes taking care not to scald yourself in doing so.
7. Check that the drain and fill hoses are not kinked and have been fitted correctly.
8. Does the drain trap need cleaning? (See page 7.) - A blocked drain trap may also prevent machine spinning.

### **Additionally:**

9. If your washing is still wet at the end of the spin cycle check:
  - That the spin cycle was selected by the spin control switch.
  - That the special feature of the machine which insures the laundry is evenly distributed around the cylinder, has not caused the machine to revert to the tumble condition to redistribute the load.
  - This can happen if an awkward item like a double bed sheet is being washed.

**Note:** If on making a service call, our engineer discovers that the only attention required is to remedy one of the above conditions, a charge will have to be made whether the machine is in or out of the guarantee period, or under Service Contract.

Please do not telephone for service until you are sure it is required.

### **Moving House**

Disconnect mains services i.e. water and electricity. When transporting the appliance it is advisable to keep it in an upright position.

If in doubt, contact your authorised Bendix Service Centre.

**THORN EMI DOMESTIC APPLIANCES LIMITED  
SERVICE DEPOTS**

**ABERDEEN:** 0224 572586

**ALDERSHOT:** 4 Blackwater Trading Estate, Lower Farnham Road, Aldershot GU12 4EX.  
Tel: 0252 29555. Telex: 858876

**BELFAST:** Prince Regent Road, Castlereagh, Belfast BT5 6QR.  
Tel: 0232 793209. Telex: 74695

**BIRMINGHAM:** Unit 15, Charlton Drive, Corngreaves Trading Estate, Cradley Heath,  
Warley, West Midlands B64 7BJ. Tel: 0384 64971. Telex: 336617

**BRISTOL:** Arno's Castle Trading Estate, Bath Road, Brislington, Bristol BS4 3JJ.  
Tel: 0272 773741. Telex: 449202

**CAMBRIDGE:** Broad Lane, Cottenham, Cambridge CB4 4SW.  
Tel: 0954 50025. Telex: 81312

**CANVEY ISLAND:** 2-4 Sandhurst, Kings Road, Canvey Island, Essex SS8 0QY.  
Tel: 0268 694144. Telex: 99416

**CARDIFF:** Guardian Industrial Estate, Clydesmuir Road, Tremorfa, Cardiff CF2 2QS.  
Tel: 0222 460131. Telex: 498616

**DUBLIN:** THORN EMI Carlile Ltd, Long Mile Road, Dublin 12. Tel: (01) 518666

**ELGIN:** Tel: 0343 45280

**GATESHEAD:** First Avenue, Team Valley Trading Est., Low Fell,  
Gateshead, Tyne & Wear NE11 OPW. Tel: 0632 4873321. Telex: 537314.

**GLASGOW:** 20 Cunningham Road, Clyde Estate, Rutherglen, Glasgow G73 1PP.  
Tel: 041 647 4381. Telex: 779628

**GRIMSBY:** 0472 360689

**INVERNESS:** 0463 233018

**KENDAL:** 0539 31158

**LONDON:** Empire Way, Wembley, Middlesex HA9 0BA. Tel: 01 903 3421. Telex: 925755

**MANCHESTER:** Ashton Street, Dukinfield, Cheshire SK16 4RN.  
Tel: 061 330 5081. Telex: 666541

**NEWTON ABBOT:** NAM Unit, Battle Road, Heathfield, Newton Abbot, Devon TQ12 6TE.  
Tel: 0626 832033. Telex: 42656

**NORTHAMPTON:** 0604 36669

**NORWICH:** 0603 617968

**NOTTINGHAM:** Acorn Park, Midway City Industrial Estate, Dunkirk, Nottingham NG7 2TN.  
Tel: 0602 861131. Telex: 377251

**OXFORD:** Station Lane, Witney OX8 6BL. Tel: 0993 4411. Telex: 83393

**PORTSMOUTH:** Area Service Office, Limberline Road, Hilsea, Portsmouth PO3 5JJ.  
Tel: 0705 667411. Telex: 86735

**SOUTHPORT:** Slaidburn Crescent, Fylde Road Industrial Estate, Southport PR9 9YF.  
Tel: 0704 29221. Telex: 677201

**TAUNTON:** 0823 51137

**TELFORD:** Unit D2, Stafford Park 4, Telford, Salop TF3 3AS. Tel: 0952 618721. Telex: 35417

**TONBRIDGE:** 36 Morley Road, Tonbridge, Kent TN9 1RA. Tel: 0732 357722. Telex: 95269

**TRURO:** 0872 78702

**WAKEFIELD:** Monckton Farm, Industrial Estate, Denby Dale Road, Wakefield WF2 7AU.  
Tel: 0924 371851. Telex: 557744

**WREXHAM:** 0978 261847

**YORK:** 0978 641700





**THORN EMI**  
**Domestic Appliances Limited**

New Lane, Buzant, Hampshire PO9 2NH

82268/1